

Experimental V2X Evaluation for C-V2X and ITS-G5 Technologies in a Real-Life Highway Environment

Vasilis Maglogiannis[†], Dries Naudts[†], Seilendria Hadiwardoyo, Daniel van den Akker, Johann Marquez-Barja and Ingrid Moerman

Abstract—In the coming years, connectivity between vehicles with autonomous driving features and roadside infrastructure will become more and more a reality on our roads, pursuing to improve road safety and traffic efficiency. In this regard, two main communication standards are considered as key enablers, that is ITS-G5 (based on IEEE 802.11p) and C-V2X (3GPP). To assess the real performance of these technologies, there is still need for an objective and independent one-to-one comparison of these technologies using off-the-shelf hardware under identical and real-life traffic conditions. Until today, performance evaluations are limited to simulations, emulations or individual technology assessments in real-life circumstances. In this paper, an exhaustive and fair evaluation of the technologies has been conducted in a real-life highway environment under identical conditions. Tailored evaluation tools in combination with our in-house CAMINO vehicular framework has been utilized to perform the tests and analyze the results for different well-specified test cases. The performance evaluation shows that for the short-range technologies, C-V2X PC5 has, in general, a higher range than ITS-G5, while ITS-G5 offers lower latency than C-V2X PC5 in low-density scenarios. Long-range 4G C-V2X can be considered as an alternative for certain use cases. The outcome of this experimentation study can be used as valuable information for the further development of future (5G) connected and autonomous driving.

Index Terms—V2X, vehicular, communication, C-V2X, ITS-G5, cellular, 4G, evaluation, CCAM, C-ITS, V2V, V2I, testbed, field trial.

I. INTRODUCTION

In the next decades, vehicles with autonomous driving functionalities are expected to become the norm on our roads. Over the last years, significant research and innovation efforts have been made to further enhance vehicles with connectivity features in order to allow exchange of information between them and their surroundings. This is also known as Vehicle-to-Everything (V2X) communication. According to the nature of the surroundings, a vehicle can communicate with other

vehicles (V2V), with roadside infrastructure (V2I), with pedestrians (V2P), with a network (V2N), etc. Autonomous and connected vehicles can significantly improve several aspects of our daily life. Today, it is estimated that about 95% of all road traffic accidents in EU are caused by human errors [1]. Autonomous and connected vehicles can drastically increase the road safety, improve traffic efficiency, reduce fuel consumption, lower the emissions of air pollutants and enable a more efficient parking system. To further support the EU countries and the European automotive industry and push them into the direction of autonomous and connected mobility, the European Commission started the Cooperative, Connected and Automated Mobility (CCAM) initiative [2].

Because of the many significant advantages that Cooperative Intelligent Transport Systems (C-ITS) offer, authorities worldwide have started assigning dedicated spectrum for V2X technologies, on a license-exempt basis in the 5.9 GHz band. In August 2008, the European Commission (EC) published the decision 2008/671/EC [3] to allocate the frequency band 5875-5905 MHz for safety-related ITS applications. Additionally, via the ECC Decision (08)01 [4], the EC indicates that European Conference of Postal and Telecommunications (CEPT) administrations shall consider the extension of ITS spectrum in 5905-5925 MHz and recommends through ECC Recommendation (08)01 [5] the use of 5855-5875 MHz for ITS non-safety applications. Figure 1 gives an overview of the 5.9GHz band in Europe. Similar decisions for ITS spectrum allocations have been made in other countries worldwide [6] such as US, China, South Korea and Australia. It is unavoidable that C-ITS systems will play a crucial role in the new era of road-safety, transportation, vehicular communications and autonomous driving.

The last decade, two wireless communication technologies have been developed to provide direct data exchange in the 5.9 GHz band (e.g. V2V and V2I). A first one is based on IEEE 802.11p [7] and consists of different ITS protocol stacks in Europe and in the U.S., namely ITS-G5 and Dedicated Short Range Communication (DSRC) respectively. A second one is the cellular based Cellular-V2X (C-V2X) PC5 technology, also known as C-V2X Sidelink. As ITS-G5 and DSRC build on top of 802.11p, they use Carrier-Sense Multiple Access with Collision Avoidance (CSMA/CA) in order to access the wireless medium. According to CSMA/CA, each station evaluates the availability of the wireless channel before a transmission. If the channel is idle, it transmits, otherwise it

Vasilis Maglogiannis, Dries Naudts and Ingrid Moerman are with imec - IDLab, Department of Information Technology at Ghent University, Technologiepark Zwijnaarde 126, B-9052 Ghent, Belgium (e-mail: vasilis.maglogiannis@ugent.be, dries.naudts@ugent.be, ingrid.moerman@ugent.be).

Seilendria Hadiwardoyo, Daniel van den Akker and Johann Marquez-Barja are with imec - IDLab, Department of Electronics-ICT at University of Antwerp, Sint-Pietersvliet 7, B-2000 Antwerp, Belgium (e-mail: seilendria.hadiwardoyo@uantwerpen.be, daniel.vandenakker@uantwerpen.be, johann.marquez-barja@uantwerpen.be).

[†]These authors contributed equally to this work.

Manuscript received April XX, 2021.

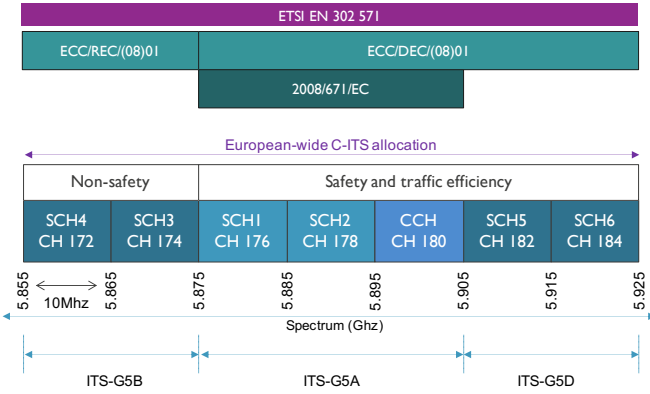

Fig. 1. C-ITS spectrum in Europe.

performs a random backoff before it estimates the availability of the channel again. Due to the nature of the CSMA/CA mechanism, the medium access time and as a result the overall packet transmission latency might increase in highly dense environments, where multiple clients compete to access the wireless medium and transmit. On the other hand, C-V2X PC5 is a newer technology that offers two operating modes, namely mode 3 and mode 4 [8]. The first mode allows ITS stations to directly exchange messages, while the base station is responsible for scheduling the resources. The latter mode allows ITS stations to autonomously schedule their resources by using sensing-based semi-persistent scheduling (SPS). According to SPS, each station schedules its own resource blocks for transmissions. In order to minimize potential collisions with other transmissions during the same moment and at the same subcarriers, each device schedules resource blocks more spread in time [9]. However, scalability might have an impact on the latency in dense environments, as multiple users may select the same resources resulting in transmission collisions. In addition, long-range communication technologies such as 4G and especially 5G, operating in their licensed spectrum, can further drive the CCAM paradigm and provide communication with cloud services [10].

In spring 2019, the European Commission (EC) published a Delegated Act on Cooperative ITS (C-ITS), based on ITS Directive 2010/40/EU [11], which defined requirements for C-ITS devices and services. The Delegated Act provided clarity around the technology to be used by automotive Original Equipment Manufacturers (OEMs), endorsing the ITS-G5 standard as the baseline technology for direct communication between vehicles and infrastructure. However, according to the European spectrum regulations, the 5.9 GHz ITS band must be technology neutral, meaning that any radio technology, which can demonstrate conformance with the essential requirements of the Radio Equipment Directive (e.g. through compliance with EN 302 571 [12]) can operate in it. Hence, the Delegated Act was rejected by the EU Member States, as it did not ensure the technology neutrality of the 5.9 GHz ITS band. The result is that today, each automotive OEM can independently select its favorable short-range communication technology, however, most car and truck manufacturers hesitate to select and integrate a specific technology, but they keep monitoring

the progress happening in both domains so that they can choose the one that potentially dominates in the future.

During the last years, many studies aimed to evaluate the different V2X wireless technologies, mainly using simulations and mathematical analysis, while there are a few cases where experiments were performed mostly on closed test tracks. However, to the best of our knowledge, there is still lack of one-to-one comparison of these technologies in real-life conditions and in the non-deterministic environment of public roads. This article aims to bridge this gap by presenting the performance evaluation of different V2X technologies, based on selected Key Performance Indicators (KPIs), in the real-life conditions of a highway. The evaluation has been performed using in-house developed tools, on top of a cutting edge test site, the Smart Highway testbed [13], which provides Commercial Off-the-Shelf (COTS) and Software-Defined Radio (SDR) equipment for both short-range and long-range wireless technologies along the E313 highway in Belgium.

The remainder of the article is organized as follows. Section II gives an overview of the current literature on the evaluation of the different V2X technologies. In Section III, we present the Smart Highway testbed and the hardware equipment that has been used in the context of this article. Section IV describes (1) the methodology according to which we performed the tests and (2) the tools that have been developed and used for performing the experiments and analyzing the collected results. In Section V, we discuss the different test cases and the selected KPIs based on which the technology evaluation has been performed. Next, Section VI presents the performance results of the different V2X technologies in the real-life conditions of the E313 highway. Finally, Section VII concludes the article and discusses our plans for future work.

II. RELATED WORK

The European ITS-G5 standard and its US variant DSRC are well-established and mature technologies, which have been studied and evaluated through simulations and mathematical analysis but also in several test campaigns and pilots in Europe and worldwide. On the contrast, C-V2X PC5 is a newer technology that has not been evaluated extensively yet in realistic conditions.

In [14], a novel analytical model for 802.11p is presented that takes into account the impact of mobility, the impact of transceivers' speed on the system's reliability, the channel fading and the presence of hidden terminals. The results show that current specifications may lead to severe performance degradation in dense and high mobility scenarios. To increase the system's reliability, the authors propose an adaptive algorithm to dynamically change parameters such as sending rate, transmission power, carrier sense range and minimum contention window size based on the environment conditions.

In [15], the authors aim to compare the performance of 802.11p and C-V2X PC5 mode 3 in terms of user density, modulation and coding scheme (MCS) and message frequency, based on analytical models. The 802.11p model considers the impact of capture effect and hidden terminal, while the C-V2X PC5 model takes into account the impact of imperfect

knowledge of the vehicle position on the resource allocation. The study shows that 802.11p is more robust than C-V2X PC5 mainly at limited distances. At longer distances C-V2X is more reliable than ITS-G5 that may suffer from interference caused by hidden terminals.

The authors in [16] compare the performance of ITS-G5 and C-V2X PC5 mode 4 for both the physical and the MAC layer based on simulations. Initially, they describe the protocol details of the two communication systems, indicating that C-V2X PC5 offers higher configuration flexibility compared to ITS-G5. The performance of the two technologies was evaluated in terms of Packet Error Rate (PER) versus Signal-to-Noise Ratio (SNR), range and latency. The simulation results show that C-V2X PC5 has better performance in terms of PER and range for lower levels of vehicles density (e.g. lower than $150\text{users}/\text{km}^2$). However, ITS-G5 outperforms C-V2X PC5 when the level of congestion increases further. Regarding the latency, the authors show that for low user density and operating range, ITS-G5 offers lower latency than C-V2X PC5 due to the different channel access mechanism that the two technologies use. Nevertheless, C-V2X PC5 may offer lower latency than ITS-G5 in high user density environments.

The studies in [8], [17] aim to analyze through modeling or simulations the performance of C-V2X mode 4. The study in [8] examines the packet delivery ratio for different distances and different packet rates. It is shown that the SPS can result in a significant amount of packet collisions and decreased performance for longer distance and higher channel load. In [17], the authors present the first open-source C-V2X simulator implemented in NS3 and investigate SPS parameters, showing that SPS has limited performance in highly congested networks.

Although the mathematical and simulation studies give meaningful results about the performance of the technologies, they mainly focus on performance related KPIs, ignoring hardware and environment related aspects and complex interactions, such as signal power, signal propagation, reflections, equipment limitations, protocol designs, etc. that may have a significant impact on the real-life performance of the wireless technologies. A number of works have evaluated the performance of 802.11p [18], [19], and the performance of C-V2X PC5 [20], [21] by performing field experiments. However, these studies either focus on a single technology targeting specific use cases or perform experiments on closed-circuit test tracks rather than public streets with dynamically changing conditions, hereby restricting the possible tests and observations.

In the past years, the Intercor project has demonstrated a large-scale interoperable deployment of C-ITS and evaluated the performance of using ITS-G5 and Cellular communication channels, both separately and combined in a hybrid configuration [26]. A series of test were carried out across the participating member state (France, the Netherlands, UK and Belgium) to prove large scale interoperability and continuation of service, during cross border testing. In the report, detailed results are presented of the technical evaluation, impact assessment and user acceptance from the four pilot evaluations. The results, however do not include the assessment of C-V2X

PC5 technology.

This article aims to contribute to the state of the art by providing a fair evaluation of the different V2X communication technologies, including both short-range ITS-G5 and C-V2X, and long-range 4G C-V2X (through the Uu interface) in a real-life highway environment. In current SoA, comparative evaluation on selected V2X technologies is done in simulation or controlled environments. The V2X technologies are evaluated based on selected KPIs, using commercial hardware on top of the Smart Highway testbed, and the in-house developed communication management framework, accompanied with advanced post-processing evaluation tools. The V2X technologies have been evaluated in a fair manner, for a series of interesting test cases and under exactly the same conditions, including transmission related parameters (simultaneous transmissions, packet sizes, transmission intervals), highway environment conditions (traffic density, obstacles, street curvatures) and weather conditions.

III. THE SMART HIGHWAY TESTBED

A. Testbed Description

For the performance evaluation of the different V2X technologies, namely the short-range C-V2X PC5 mode 4 and ITS-G5, and the long-range 4G C-V2X Uu, the Smart Highway testbed has been used. Specifically for C-V2X PC5, we consider mode 4 only as mode 3 equipment is not yet available in the market. Smart Highway is a cutting-edge C-ITS testbed deployed by IMEC at main highway locations in Flanders (across the E313 highway near Antwerp) and shall be extended to the (urban) road network. The Smart Highway testbed consists of eight Road-Side Units (RSUs) with Multi-Access Edge Computing (MEC) capabilities and two On-Board Units (OBUs) that can be integrated in vehicles. Seven of the RSUs are deployed along the E313 highway at the locations shown in Figure 2, while one is setup in a lab environment, so that the implemented services and tools can be safely tested before they are deployed at the highway. Figure 3 shows the roadside infrastructure and the vehicle that have been used for the evaluation of V2X technologies. The testbed is a unique platform that allows in-depth experimental analysis in view of novel C-ITS use-cases, by exploiting COTS and SDR equipment for both legacy and future technologies. The Smart Highway testbed offers an ideal environment for research and experimentation with short- and long-range V2X technologies. Researchers or experimenters can exploit real hardware in non-deterministic conditions, like variable vehicle speeds, dynamic vehicle typologies, weather conditions and traffic densities.

1) *V2X On Board Units*: The Smart Highway OBUs can be mounted on vehicles in order to enable them to communicate with other vehicles, roadside infrastructure and cloud services. The OBU architecture is split into two separate units. The first one is installed inside the vehicle and contains the processing component for the Lidar (Nvidia Jetson computer board), the power system and the in-vehicle sensor processing modules (e.g. CAN processing). The second unit is installed on the roof of the vehicle and is only connected to the in-vehicle OBU with an Ethernet and power connections. The



Fig. 2. The locations of the RSUs deployed along the E313 highway.



Fig. 3. Vehicle and roadside infrastructure at the highway.

roof unit contains all the V2X communication hardware, the V2X processing hardware, the SDR equipment and the Global Navigation Satellite System (GNSS) device. The antennas of the communication modules are also attached on the roof of the vehicle. Figure 4 illustrates the overview of the OBU architecture.

2) *Roadside infrastructure*: The equipment that is deployed along the roadside to support C-ITS services and to enable connected, cooperative and autonomous features is called the roadside ITS subsystem or more commonly referred to as RSU. The RSUs allow data message exchange between the vehicles and the infrastructure (V2I/I2V) via short- and long-range communication technologies. The RSU can also act as a router to forward data from vehicles to other vehicles (V2I2V), RSUs or the central ITS subsystem (V2N/N2V) using different types of backhauling technologies, such as optical fibre, wireless backhauling, etc. Different types of sensors may also be attached to the RSU such as cameras, Lidar, traffic lights, environmental sensors (e.g. fog sensor). This way, these sensors can be integrated into the C-ITS system. Each RSU of the Smart Highway testbed contains V2X wireless communication modules, as well as processing hardware for performing computations on the RSU itself,

a GNSS device and SDR equipment. In addition, it also contains a number of modules that are needed both to support performing experiments on the RSU and to allow the RSU to be managed and recovered remotely. The summary of the RSU architecture is presented in Figure 5.

B. Reference Use Cases

This section describes reference use cases that have been considered for the evaluation of the V2X communication technologies, both short-range (C-V2X and ITS-G5) and long-range (4G). These indicative use cases are mainly classified into two categories as adopted in the EC framework [22], namely Hazardous Location Notifications (HLN) and signage applications. More specifically, from the HLN category, the reference use cases include Emergency Electronic Brake Light (EEBL), Slow or Stationary Vehicle (SSV) and Road Works Warning (RRW), while from the signage applications, the In-Vehicle Signage (IVS) use case has been selected.

The aforementioned use cases exploit several C-ITS services, such as Cooperative Awareness (CA) [23], Decentralized Environment Notification (DEN) [24] and Infrastructure to Vehicle Information (IVI) [25], transmitting standardized

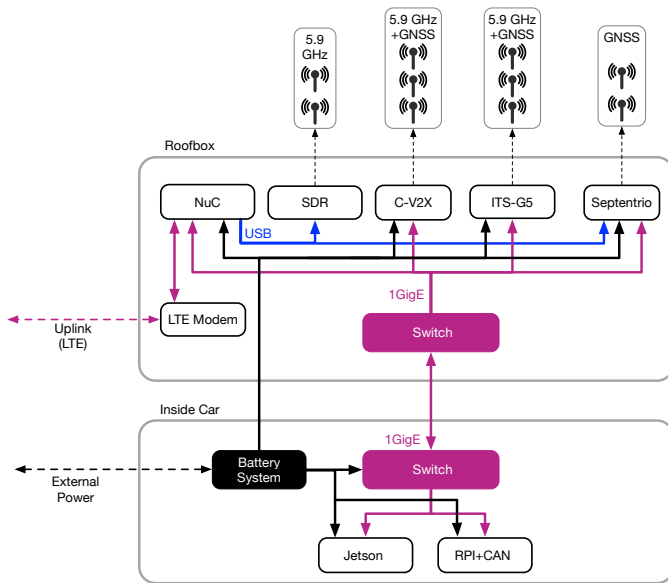

Fig. 4. Overview of the OBU architecture.

messages such as Cooperative Awareness Message (CAM), Decentralized Environmental Notification Message (DENM) and Infrastructure to Vehicle Information Message (IVIM).

1) *Hazardous Location Notifications*: According to HLN use cases, approaching drivers are warned about a hazardous situation on the road ahead (e.g. obstacles in the road). HLN are preventive safety services, as drivers will have more time to prepare for the hazard and avoid a potential accident. Through V2I or V2V messages, roadside infrastructure or other vehicles respectively could warn a driver or an autonomous vehicle about detected dangerous situations such as a slow/stationary vehicle, roadworks, emergency braking ahead, etc. To distribute a warning message over longer distances so that other approaching vehicles can prepare on time, the vehicle or the roadside infrastructure that detects a hazard may transmit the information to nearby roadside units that in their turn can disseminate it to even more vehicles. Within the HLN use cases, a driver or an autonomous vehicle is warned through dynamically triggered DENM and periodically transmitted CAM messages that are distributed via short-range V2X technologies (C-V2X PC5 or ITS-G5) and potentially via long-range cellular technologies (4G/5G C-V2X Uu).

2) *Signage Applications*: Variable or Dynamic Message Sign (VMS) systems have been deployed on sensitive parts of the motorway network all over Europe. These systems are being used to enforce traffic regulations (e.g., speed and lane management) and inform road users about driving conditions, travel times, hazardous events and possible alternative routes. According to the IVS use case, the road users receive in-car speed limit notifications, as well as lane management and lane status information as they drive. The aim of IVS is to relay the information presented on the (electronic) traffic signs into the vehicle. The information on the dynamic speed limit and lane status is transmitted via V2X technologies to the vehicles using IVIM, so that the drivers or autonomous vehicles are informed

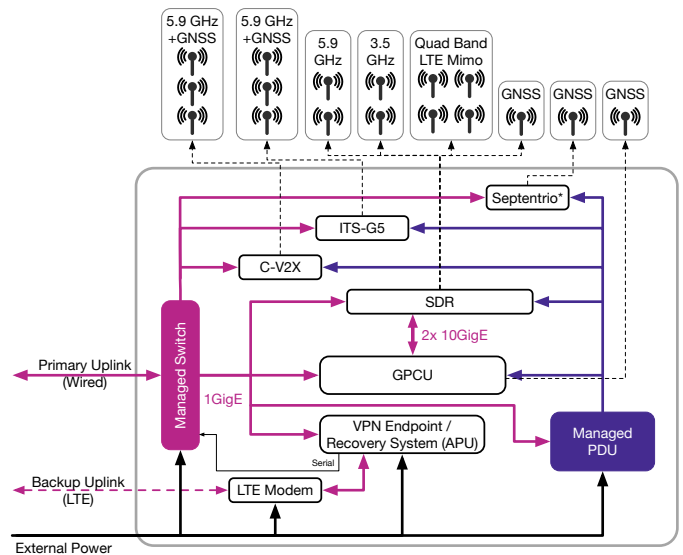

Fig. 5. Overview of the RSU architecture.

about the current speed limits and lane statuses, due to the conditions on the highway such as traffic jam, roadworks, etc.

IV. TESTING METHODOLOGY AND EVALUATION TOOLS

A. Methodology Overview

This section gives an overview of the methodology that has been followed for the evaluation of the different V2X technologies on top of the Smart Highway testbed.

In order to have a fair comparison of the short-range communication performance for ITS-G5 and C-V2X PC5, both technologies have been configured to transmit simultaneously, but in different channels in the 5.9 GHz ITS band. This way, we can evaluate their performance for exactly the same conditions, including distance between the transmitter and the receiver, traffic conditions, obstacles, etc. The investigated ITS channels are the 176, 180 and 184. These channels are not neighboring and the bandwidth between them has been used as guard frequency. In order to take into account any propagation variation due to the frequency differentiation, each test has been repeated with C-V2X PC5 and ITS-G5 operating in every combination of the three considered channels, excluding the

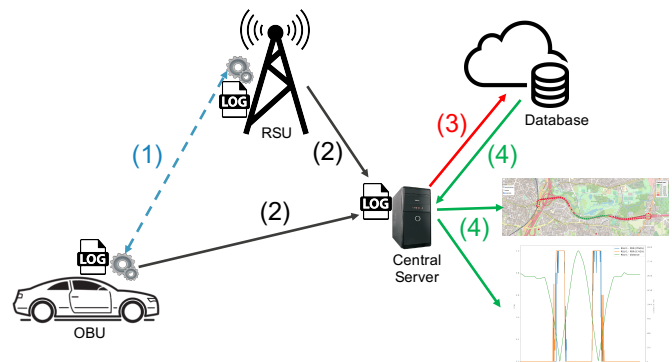

Fig. 6. Overview of the testing methodology.

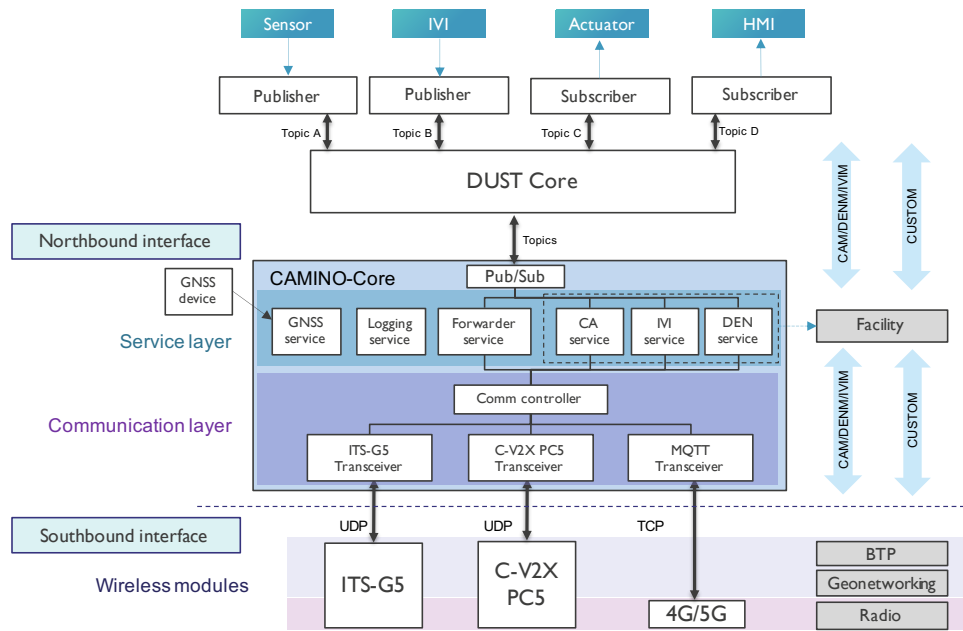

Fig. 7. Overall CAMINO framework architecture.

use of a common channel that would cause mutual interference. Additionally, every single test has been repeated using the same settings for several times in order to evaluate and verify the reproducibility of the results. The GNSS device is used by all the RSUs and OBUs for timing synchronization through the use of the Network Time Protocol (NTP) [28]. According to the specifications of the used GNSS devices, they offer a time accuracy of $1ms$. However, we have noticed that occasionally the accuracy may decrease by a few milliseconds. Nevertheless, as mentioned, that impact would be reflected on both technologies as they transmit simultaneously using the same clocks and in addition, each test as been repeated multiple times and during different dates. Hence, we believe that the impact of the variation in GNSS synchronization through NTP on the performance evaluation can be considered negligible.

Figure 6 illustrates the used methodology, showing all the steps that are followed in order to translate the data transmitted between the vehicles and the RSUs to graphs that evaluate the selected KPIs. As it is shown in the figure, during the first step, the OBUs and RSUs transmit and/or receive data that can be CAM, DENM or IVIM messages using the selected V2X communication technologies, according to the selected test case. The transmitted and received messages are logged locally at both the OBUs and the RSUs. Local logging guarantees that data will not get lost due to potential connectivity interruptions with a remote database during the tests. The logging of the data is being done according to the Intercoor logging format [29] in order to ensure the consistency of the logged data based on a common logging format. The management of the different V2X technologies, the services running on top of them and the logging of the transmitted and received messages is handled by the in-house designed and developed vehiCulAr coMmuniCation maNagement framewOrk (CAMINO) framework [30]

that is further described in Section IV-B. After the end of a test, all the locally logged data from all the participating OBUs and RSUs are collected to the central logging server (step 2 of the testing methodology). From there, the data are uploaded to the central database (step 3). After the data are inserted to the database, they can be used from the post-processing tools for the analysis of the defined KPIs (step 4).

B. The CAMINO Framework

CAMINO is the core framework for managing the V2X communication technologies of the Smart Highway testbed and the services running on top of them. The framework enables integration with existing and future short- and long-range V2X technologies such as ITS-G5, C-V2X PC5 and C-V2X Uu (5G/4G). Moreover, it allows integration with vehicle or roadside infrastructure sensors, vehicle actuators, Human-Machine Interfaces (HMIs) and third-party service providers. CAMINO supports several standardized C-ITS services (e.g. CA, DEN, IVI) that can be triggered dynamically. Additionally, it can easily be extended in a modular way with future or custom C-ITS services. The generated messages can be transmitted in a flexible way by one or multiple V2X technologies (hybrid-V2X communication) increasing the transmission capacity or enhancing the transmission reliability. Furthermore, the CAMINO framework can run on top of any type of ITS device such as OBU, RSU, UE, servers, etc. It offers rich logging capabilities that allow the collection of valuable information for evaluating the performance of the V2X technologies and the services running on top of them. Figure 7 presents the overall architecture of the CAMINO framework.

The CAMINO-Core is the heart of the framework, implementing the main functionality that is required to control the incoming and outgoing data flows between the northbound and

	ts2 timestamp	ts2 log_station_id	ts2 application_id	ts2 action	ts2 station_id	ts2 communication_profile	ts2 message_type	ts2 generation_timestamp_tsi	ts2 generation_timestamp_utc	ts2 asn1_data
1	1,607,592,509,942	102	1	SENT	102	ITS_G5	ETSI-CAM	1,607,592,509,941	1,607,592,509,941	01020000066927D005D693A40
2	1,607,592,509,942	102	1	SENT	102	LTE_V2X	ETSI-CAM	1,607,592,546,941	1,607,592,509,941	01020000066927D005D693A40
3	1,607,592,510,041	102	1	SENT	102	ITS_G5	ETSI-CAM	1,607,592,547,041	1,607,592,510,041	0102000006692E1005D693A40
4	1,607,592,510,042	102	1	SENT	102	LTE_V2X	ETSI-CAM	1,607,592,547,041	1,607,592,510,041	0102000006692E1005D693A40
5	1,607,592,510,142	102	1	SENT	102	ITS_G5	ETSI-CAM	1,607,592,547,141	1,607,592,510,141	010200000669345005D693A40
6	1,607,592,510,142	102	1	SENT	102	LTE_V2X	ETSI-CAM	1,607,592,547,141	1,607,592,510,141	010200000669345005D693A40
7	1,607,592,510,242	102	1	SENT	102	ITS_G5	ETSI-CAM	1,607,592,547,242	1,607,592,510,242	0102000006693AA005D693A40
8	1,607,592,510,242	102	1	SENT	102	LTE_V2X	ETSI-CAM	1,607,592,547,242	1,607,592,510,242	0102000006693AA005D693A40
9	1,607,592,510,342	102	1	SENT	102	ITS_G5	ETSI-CAM	1,607,592,547,342	1,607,592,510,342	01020000066940E005D693A40
10	1,607,592,510,342	102	1	SENT	102	LTE_V2X	ETSI-CAM	1,607,592,547,342	1,607,592,510,342	01020000066940E005D693A40
11	1,607,592,510,442	102	1	SENT	102	ITS_G5	ETSI-CAM	1,607,592,547,442	1,607,592,510,442	010200000669472005D693A40
12	1,607,592,510,442	102	1	SENT	102	LTE_V2X	ETSI-CAM	1,607,592,547,442	1,607,592,510,442	010200000669472005D693A40
13	1,607,592,510,543	102	1	SENT	102	ITS_G5	ETSI-CAM	1,607,592,547,542	1,607,592,510,542	0102000006694D6005D693A40
14	1,607,592,510,543	102	1	SENT	102	LTE_V2X	ETSI-CAM	1,607,592,547,542	1,607,592,510,542	0102000006694D6005D693A40
15	1,607,592,510,643	102	1	SENT	102	ITS_G5	ETSI-CAM	1,607,592,547,642	1,607,592,510,642	01020000066953A005D693A40
16	1,607,592,510,643	102	1	SENT	102	LTE_V2X	ETSI-CAM	1,607,592,547,642	1,607,592,510,642	01020000066953A005D693A40
17	1,607,592,510,743	102	1	SENT	102	ITS_G5	ETSI-CAM	1,607,592,547,743	1,607,592,510,743	0102000006695F0005D693A40
18	1,607,592,510,743	102	1	SENT	102	LTE_V2X	ETSI-CAM	1,607,592,547,743	1,607,592,510,743	0102000006695F0005D693A40
19	1,607,592,510,843	102	1	SENT	102	ITS_G5	ETSI-CAM	1,607,592,547,843	1,607,592,510,843	010200000669630005D693A40
20	1,607,592,510,844	102	1	SENT	102	LTE_V2X	ETSI-CAM	1,607,592,547,843	1,607,592,510,843	010200000669630005D693A40
21	1,607,592,510,944	102	1	SENT	102	ITS_G5	ETSI-CAM	1,607,592,547,943	1,607,592,510,943	010200000669670005D693A40
22	1,607,592,510,944	102	1	SENT	102	LTE_V2X	ETSI-CAM	1,607,592,547,943	1,607,592,510,943	010200000669670005D693A40
23	1,607,592,511,044	102	1	SENT	102	ITS_G5	ETSI-CAM	1,607,592,548,043	1,607,592,511,043	0102000006696C8005D693A40
24	1,607,592,511,044	102	1	SENT	102	LTE_V2X	ETSI-CAM	1,607,592,548,043	1,607,592,511,043	0102000006696C8005D693A40
25	1,607,592,511,144	102	1	SENT	102	ITS_G5	ETSI-CAM	1,607,592,548,144	1,607,592,511,144	010200000669730005D693A40

Fig. 8. Snapshot of the Smart Highway central database.

southbound interfaces. At the southbound interface, CAMINO-Core interconnects with the different V2X wireless technologies, using the several transceiver classes. For example, it can communicate with commercial C-V2X PC5 and ITS-G5 modules via UDP sockets and with an MQTT broker through TCP over wired or cellular networks. The transceiver classes can interact with the CAMINO-Core services via the Communication (Comm) Controller. At the northbound interface, CAMINO-Core is integrated with the Distributed Uniform Streaming (DUST) open source framework [31] that provides interconnection to sensors, actuators, third-party services and HMIs by using a publisher/subscriber architecture. The CAMINO framework provides a series of publishers that can be used to trigger specific services at the CAMINO-Core based on information that may derive from the CAN BUS or the sensors of the vehicle and a series of subscribers that bring the information from the different ITS services in the vehicle. This information then may be used to trigger an actuator or to be visualized using an HMI. The facility layer of the ITS stack, as specified in ETSI, can be managed by the CAMINO-Core. Several C-ITS standardized (e.g. CA, DEN, IVI) or custom services are supported that can run independently or simultaneously. Furthermore, the CAMINO-Core provides the logging service that enables the logging of transmitted or received messages, triggered events, positioning information, etc. More detailed information about the CAMINO framework can be found in [30].

C. Logging of Data

In order to collect all the data from the different tests in a central point, a MySQL database has been created on the logging server of the Smart Highway testbed. This way, the collected data are organized based on the date that the tests have been performed. As it was mentioned in Section IV-A, during each test, each OBU and RSU logs the transmitted and received data locally to avoid data being lost due to potential connectivity interruptions. After the end of each test campaign, all the local log files are copied to the central server. From there, an in-house developed tool parses all the files and checks the consistency of the collected data, while potentially corrupted data are dropped. Subsequently, the tool uploads all the data to the database. In addition to the log files that

are uploaded to the database, for each test campaign a test description table is created that includes detailed information for each test. Such information among others contains the experiment ID, the date, the start and end time of each test, the test description, the weather conditions and several test-related data such as the type of messages used (e.g. CAM, DENM, IVIM), the frequency of each transmitted message, whether security was enabled, etc. Figure 8 shows a snapshot of CAM messages logged in the central database during the test campaign on the 10th of December 2020.

D. Post-Processing Tools

In order to evaluate the different V2X technologies based on the selected KPIs, we have developed a series of post processing tools that are capable to process the logged data that have been collected during the test campaigns. The tools are able to connect to the central database and access the stored data. Based on these tools, we have evaluated several selected KPIs related to the performance of the different V2X technologies (C-V2X Uu, C-V2X PC5 and ITS-G5) including packet delivery rate (PDR) in function of both distance and time, packet-loss over specific distance bins and end-to-end (E2E) one-way latency over time. Additionally, the tools allow the representation of evaluated data in different formats including graphs and interactive maps.

1) *PDR measurement tool*: The PDR measurement tool computes the PDR between a transmitting and a receiving ITS node. These plots allow us to evaluate the performance of each technology individually, or directly compare the different technologies with each other. Furthermore, the PDR measurement tool is able to compute the PDR of transmitted packets over time for a specified time resolution. In addition, the PDR can be shown in relation to the distance between the transmitter and the receiver.

2) *Packet-loss measurement tool*: The packet-loss measurement tool computes the packet-loss between a transmitting and a receiving ITS node and plots it on a map. This map is interactive and allows an experimenter to choose the desired technology to be plotted, zoom in and out, and click on each measurement point to see the exact values of the packet-loss for the considered V2X technologies.

TABLE I
SCENARIOS, OBJECTIVES AND SETTINGS OF THE CONSIDERED TEST CASES.

Test Case	Scenario	Objectives	Technologies	Communication Range	Frequency Channel	Transmission Rate	Message type
V2I evaluation	A vehicle equipped with OBU drives along the RSUs. The OBU and RSUs transmit CAMs at specific rate. Tests performed in different frequency channels.	Evaluation of KPIs for communication between RSU and OBU.	C-V2X PC5, ITS-G5	short-range	176, 180, 184	1, 5, 10Hz	CAM
V2V evaluation	Vehicles equipped with OBU drive in the same or opposite directions. The OBUs transmit CAMs and DENMs at specific rate. Tests performed in different frequency channels.	Evaluation of KPIs for communication between OBUs 1) driving at the same direction 2) driving at the opposite direction.	C-V2X PC5, ITS-G5, C-V2X Uu	short-range, long-range	176, 180	1, 5, 10Hz	CAM, DENM (300, 600 bytes)
Short-range security	Vehicles equipped with OBU drive along the RSUs. The OBU and RSUs transmit CAMs at specific rate. Tests are being done for enabled and disabled software-based security.	Impact of software-based security on C-V2X PC5 and ITS-G5	C-V2X PC5, ITS-G5	short-range	176, 180, 184	10Hz	CAM
Cross-country interoperability	A Belgian vehicle equipped with OBU drives along the Dutch RSUs. The OBU and RSUs transmit CAMs, DENMs and IVIMs at specific rate.	Evaluate the interoperability of V2X technologies and C-ITS solutions in cross-country sites.	C-V2X PC5, ITS-G5	short-range, long-range	180, 184	1Hz	CAM

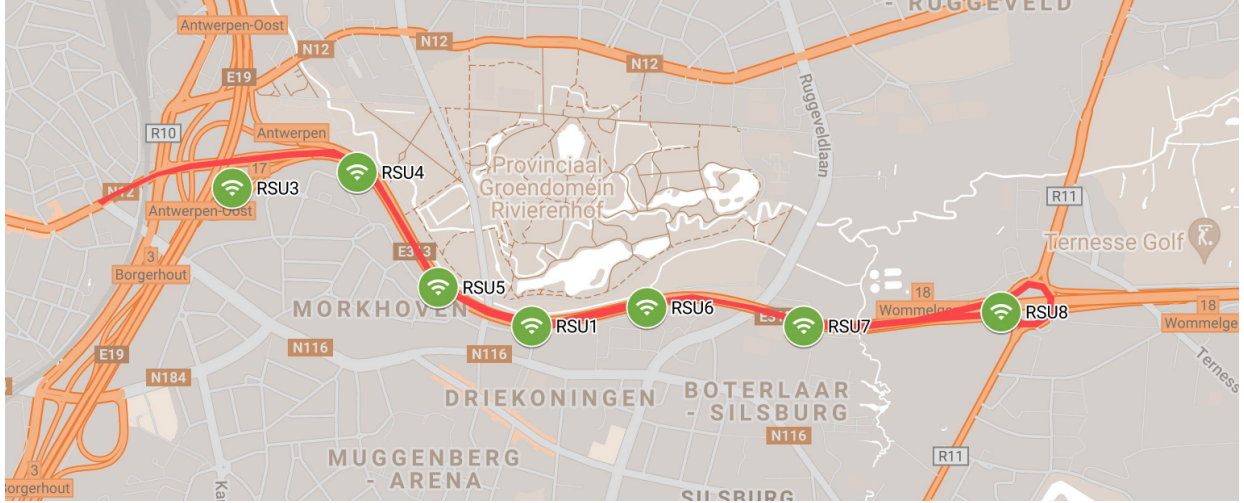

Fig. 9. V2I evaluation test trajectory.

3) *E2E one-way latency measurement tool*: The latency measurement tool calculates the E2E one-way latency of a packet transmitted from a sender to a receiver ITS node. The tool can plot the Cumulative Distribution Function (CDF) of the latency, giving useful information about the performance of each technology. By using the latency measurement tool, we can compare the latency that the technologies under consideration can offer for different parameters, such as transmitting packet size and inter-packet interval. In addition, we can investigate what is the impact of the security on the latency of the transmitted packets.

V. TEST CASES

For the performance evaluation of the different V2X wireless technologies, several test campaigns have been organized, during which, numerous tests have been executed. During each test campaigns, the considered V2X technologies have been evaluated for different test cases including V2I and V2V communications (direct and via 4G long-range) for different C-ITS services (CA, DEN and IVI) and for different configurations of selected V2X parameters such as transmitting frequency channels, transmission interval, enabled or disabled security, etc. In addition to the V2X technology evaluation along the E313 highway, selective cross-country tests have been performed at the Amsterdam pilot, using a vehicle of the Smart Highway testbed. This way, the performance of the

V2X technologies could be compared in different locations and environments. An overview of the scenarios, the objectives and the settings of the considered test cases is given in Table I. The remaining of this section describes the main test cases that have been considered for the evaluation of the V2X technologies.

A. Communication between RSU and OBU (V2I)

This test case aims to evaluate the V2I communication link between an OBU and the deployed RSUs. As it has been described in Section III, seven RSUs have been deployed across the E313 highway, near Antwerp. Figure 9 presents the test trajectory that has been followed during the V2I evaluation. The test trajectory spans a total length of 8km and includes all the seven RSUs in both traffic directions of the E313 highway, from Antwerp to Wommelgem (a suburb to the east of Antwerp) and back.

The V2I evaluation has been done through several tests that have been performed during different dates and for different settings for both ITS-G5 and C-V2X PC5 technologies. These settings include multiple frequency channels, variable transmission rates and multiple C-ITS service messages of variable size. For every test, parameters related to the environment of the trajectory have been logged, such as traffic congestion (e.g. heavy/light traffic, OBU vehicle driving behind a truck or on clear road), weather conditions (e.g. sunny or rainy)

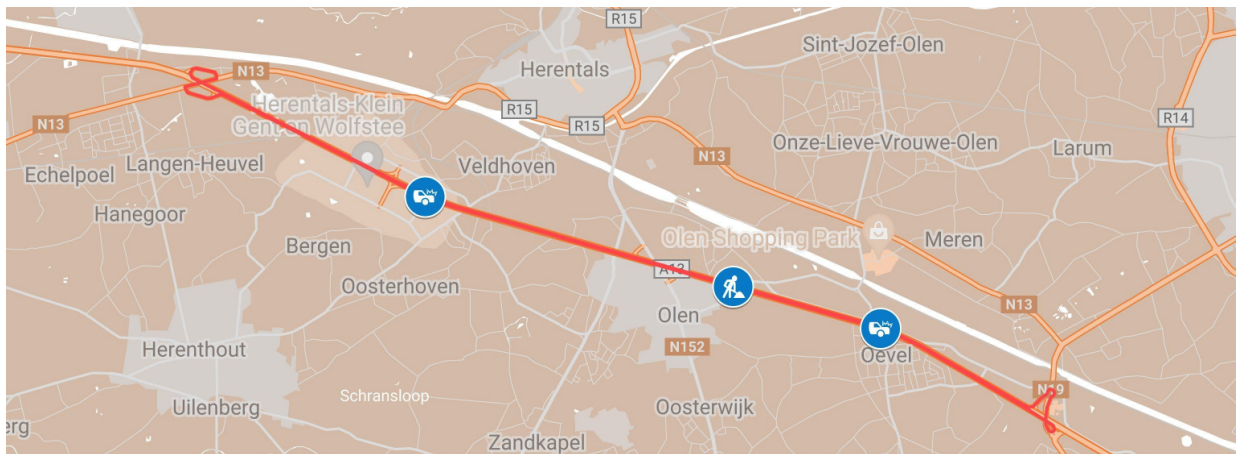

Fig. 10. V2V evaluation test trajectory.

and the driving direction on the test trajectory. This way, the performance of the wireless V2X technologies could be evaluated for different conditions both on the highway and the wireless medium.

B. Communication between OBUs (V2V)

Supplementing the V2I evaluation, the wireless communication performance between multiple OBUs (V2V) has been evaluated for both short-range ITS-G5 and C-V2X PC5 technologies, as well as the long-range 4G C-V2X Uu. Figure 10 presents the test trajectory that has been used for the V2V evaluation. The trajectory covers a total length of 30km of the E313 highway and ranges from Herentals-West to Geel (eastbound) and back (westbound).

Similar to the V2I test case, the V2X technologies have been evaluated during multiple tests performed on different days, for variable settings, such as message transmission interval and operating frequency channels. Moreover, for every test, environment and trajectory related parameters have been logged.

The performance of the V2V communication for the different technologies has been evaluated for two main scenarios, namely vehicles driving at the same direction and vehicles driving at opposite direction. During the first scenario, the two vehicles start driving close to each other and at a specific point the vehicle in front starts accelerating, increasing its distance from the following vehicle. During the second scenario, the two vehicles start driving in opposite direction towards each other from the two different sides of the test trajectories, until they eventually meet and drive away from each other. For both scenarios, the vehicles always transmit CAM messages according to the configured transmission interval.

In order to investigate the impact of different C-ITS services on each other, the vehicles dynamically transmit DENM messages for virtual events (EEBL, RRW and SSV) at the locations indicated with blue pins on the map of Figure 10 for a specific period of time and at a configurable transmission interval.

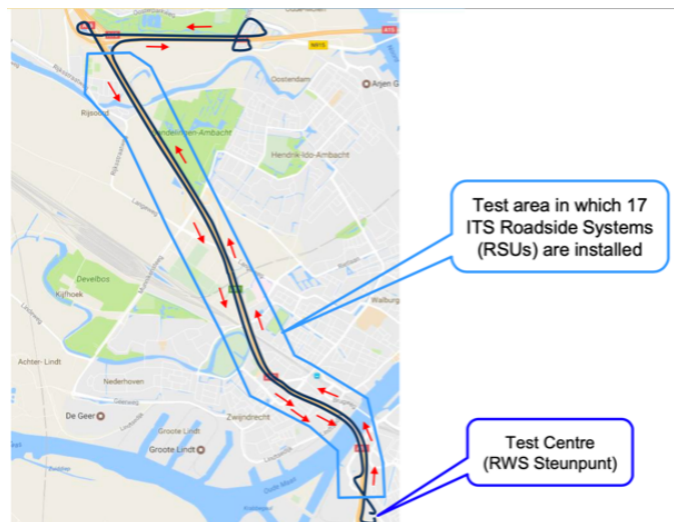

Fig. 11. MRA test trajectory for V2I evaluation.

C. Short-range security

Another interesting test case that this article considers is the impact of security implemented in software on the performance of short-range V2X technologies. In that direction, the security was configured for both the ITS-G5 and C-V2X PC5 Cohda modules and both technologies were configured to transmit and receive secured messages using ETSI v1.3 certificates provided by the ESCRYPT Public Key Infrastructure (PKI) [32] in the context of the CEF CONCORDA project [33]. During this test case, initially, the OBUs and the RSUs transmit CAM messages with a frequency of 10Hz. Then, the same test is repeated but without security.

D. Cross-country interoperability

As part of the cross-country test campaign that we conducted, measurements have been performed with the Belgian test vehicle at the Metropole Amsterdam Region (MRA) pilot site [27]. The location of the tests is at the Rijkswaterstaat A16 near Dordrecht. Fixed ITS-G5 RSUs have been placed on strategic locations on the A16. On the A16 location the

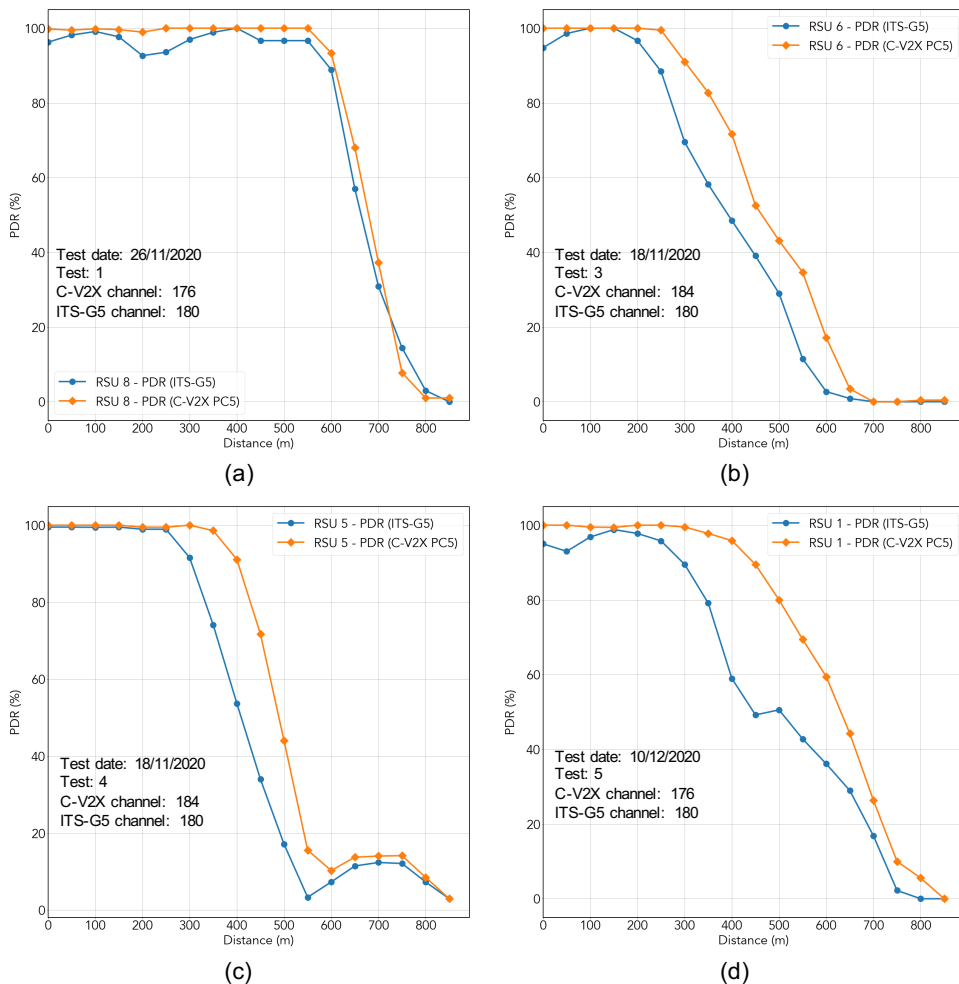

Fig. 12. PDR in relation to the distance between the (a) RSU8, (b) RSU6, (c) RSU5, (d) RSU1 and the OBU (V2I) for different tests and frequency channels.

services RWW and IVS can be tested. The RSUs send detailed information based on DENM and IVIM, such as location of the road works, available lanes and maximum permitted speed to passing vehicles with a compatible OBU. Furthermore, the RSUs transmit CAM messages with 1 second interval. The test track stretches over 17km and has been equipped with 13 fixed RSUs, mounted on existing gantries, as indicated on Figure 11. The starting point was the test centre of Rijkswaterstaat (RWS) Steunpunt. The infrastructure is suited to test the use cases for both driving directions simultaneously.

VI. EVALUATION RESULTS

This section presents and discusses the results from the evaluation of the different V2X technologies for the test cases presented in Section V.

A. Performance evaluation of V2I

As it was discussed in Section V-A, for the V2I performance evaluation, several tests have been executed aiming to measure selected KPIs, including PDR in relation to distance and time, packet-loss in relation to distance, E2E one-way latency and signal strength.

TABLE II
AVERAGE PDR OF ITS-G5 AND C-V2X PC5 FOR DISTANCE BINS OF 50 METERS FOR RSU1 AND RSU5.

Distance (m)	Average PDR for RSU1 (%)		Average PDR for RSU5 (%)	
	ITS-G5	C-V2X PC5	ITS-G5	C-V2X PC5
0	98	100	85	97
50	97	100	88	97
100	97	99	86	98
150	97	98	81	99
200	96	100	78	99
250	93	100	78	99
300	85	100	73	97
350	70	96	59	94
400	57	92	44	90
450	54	86	34	80
500	48	75	22	60
550	43	68	13	32
600	39	56	12	16
650	27	36	12	10
700	12	16	13	10
750	4	3	14	13
800	1	1	10	9
850	0	0	4	4

For the PDR evaluation, CAM messages have been sent between the RSUs and the OBU in variable rate and in

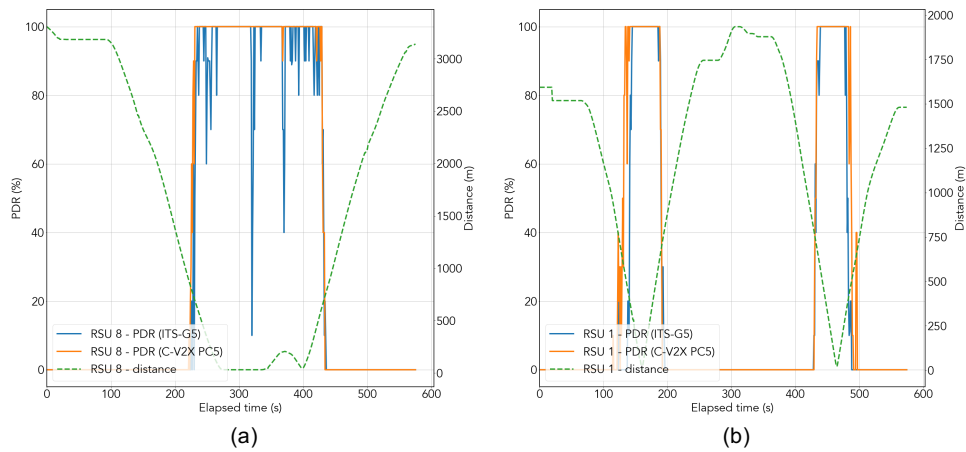

Fig. 13. PDR in relation to time and distance between (a) the RSU8 and the OBU, and (b) the RSU1 and the OBU (V2I).

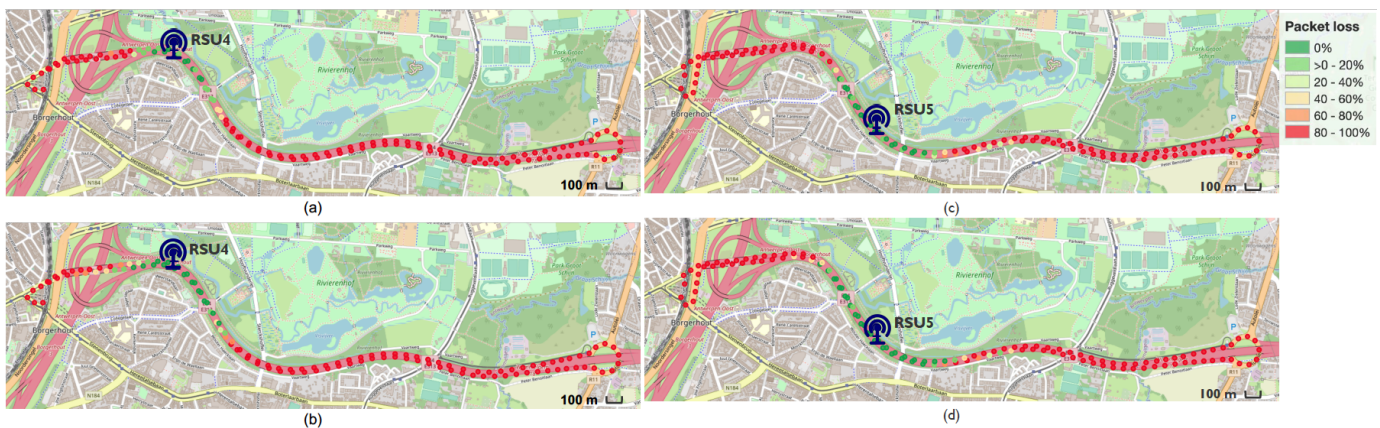

Fig. 14. Packet-loss between the RSU4 and the OBU (V2I) for (a) ITS-G5, and (b) C-V2X PC5, and packet-loss between the RSU5 and the OBU (V2I) for (c) ITS-G5, and (d) C-V2X PC5.

different frequency channels. Figure 12 shows the PDR in relation to the distance for different tests over different test days and for different RSUs. In general, it has been observed that during the tests, C-V2X PC5 outperforms ITS-G5 in distance in the majority of the cases and for all the RSUs.

From multiple test results, it was observed that the maximum distance that both technologies can reach depends on multiple environmental factors that can significantly vary, including the curves of the highway, the flora and obstacles around them, as well as the traffic conditions. Table II presents a summary of the average PDR that has been observed over the multiple tests that have been done during the V2I test campaigns for RSU1 and RSU5. The table shows that C-V2X PC5 offers a higher PDR performance over distance compared to ITS-G5 in most of the cases. For RSU1 at 400 meters, the average PDR of C-V2X PC5 is 92%, while the average PDR of ITS-G5 is only 57%. Similarly, for RSU5 at the same distance, the average PDR of C-V2X PC5 is 90%, while the average PDR of ITS-G5 is 44%. However, for RSU5, ITS-G5 offers slightly better performance than C-V2X PC5 for distances longer than 650 meters.

Figure 13 presents the graphs of PDR in relation to the time and the distance between the RSU and the OBU for

RSU8 (a) and RSU1 (b). During these tests, C-V2X PC5 was configured to operate in channel 184 and ITS-G5 in channel 180. As it can be seen, as the distance between the OBU and the RSUs becomes smaller, the PDR starts increasing and vice versa. In Figure 13(a), the distance has a small curve when the OBU is in the proximity of the RSU8. This is because RSU8 is close to the roundabout that the OBU follows in order to get to the opposite direction of the highway. Hence, as the vehicle drives in the roundabout, the distance changes. On the other hand, Figure 13(b) shows that the OBU approaches the RSU1 and drives away from it twice. This is because the vehicle drives in both directions of the highway during the test. Hence, the left part of the figure represents the direction from Antwerp to Wommelgem (eastbound) and the right one represents the direction from Wommelgem to Antwerp (westbound). In Figure 13(a), the PDR of C-V2X PC5 is more stable than the PDR of ITS-G5, when the OBU drives close to the RSU. This means that the performance of ITS-G5 is impacted more than C-V2X PC5 from the obstacles and the environment of the busy roundabout that is covered by RSU8. In Figure 13(b), both technologies have a similar PDR performance in contrast to the PDR if Figure 12(d). This can be explained by the use of different frequency channels and

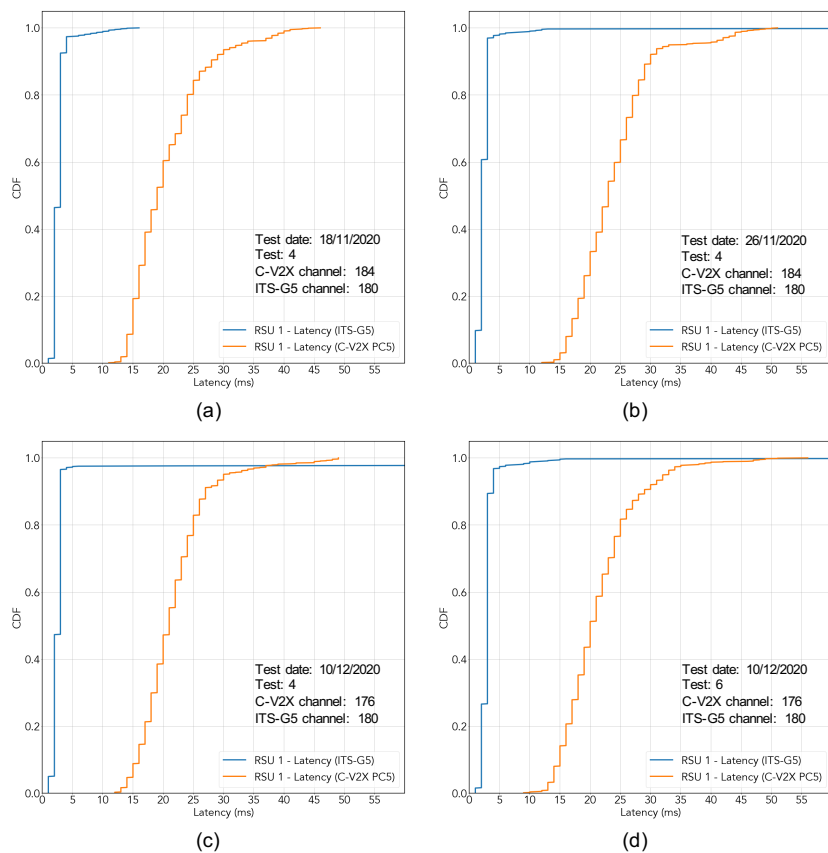

Fig. 15. End-to-end one-way latency between RSU1 and OBU (V2I) for ITS-G5 and C-V2X PC5 for different tests and frequency channels.

TABLE III
AVERAGE LATENCY OF ITS-G5 AND C-V2X PC5 FOR PERCENTILES IN STEPS.

Percentile	Latency (ms)	
	ITS-G5	C-V2X PC5
5	1.43	14.57
10	1.71	15.43
20	1.71	17.14
30	2.00	18.42
40	2.00	19.86
50	2.43	20.86
60	2.43	22.43
70	2.71	24.00
80	2.86	25.71
90	3.00	29.00
95	3.29	33.20
96	3.86	35.13
97	5.48	37.84
98	25.47	41.23
99	121.23	45.03
100	515.57	50.57

the conditions of the highway environment during the tests.

Figure 14 includes a series of maps presenting the calculated packet-loss for ITS-G5 and C-V2X PC5 at the OBU-side, for CAM messages transmitted by RSU4 and RSU5. The CAM

messages are transmitted with a frequency of $10Hz$ by both RSUs. The packet-loss is calculated for distance bins of 50 meters. The maps (a) and (c) show the respective packet-loss of ITS-G5 for RSU4 and RSU5 respectively, while the maps (b) and (d) present the packet-loss of C-V2X PC5 for the same RSUs respectively. For both RSUs, the results show that C-V2X PC5 offers higher direct communication range than ITS-G5.

In general, we can conclude that the communication range differs between different RSUs depending on several unpredictable environmental factors. The results show that for both technologies in most of the cases the packet delivery can be guaranteed with a high probability for ranges up to approximately 300 meters. Additionally, it was observed that most of the times C-V2X PC5 has a slightly higher range than ITS-G5.

The next part of the V2I evaluation focuses on the E2E one-way latency between the OBU and the RSUs. Figure 15 shows the CDF graphs of the latency for both ITS-G5 and C-V2X PC5 technologies, during multiple test-runs. As it can be observed, ITS-G5 has lower latency than C-V2X PC5 for the majority of the transmitted packets. This is related to the mechanisms that each technology uses to access to wireless medium and transmit. As explained before, ITS-G5 uses CSMA/CA for accessing the wireless medium, while C-V2X PC5 is based on sensing-based SPS. Thus, the E2E one-way latency of C-V2X PC5 is typically higher than the latency

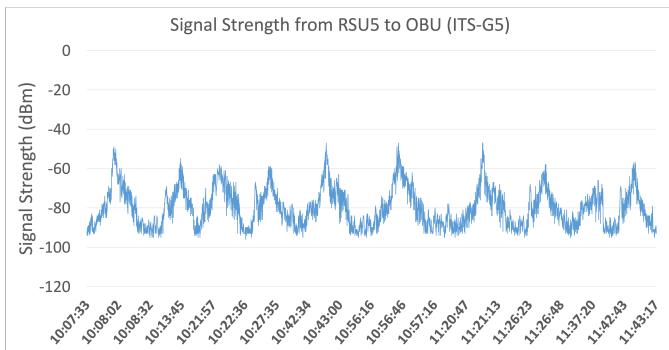

Fig. 16. OBU ITS-G5 signal strength measurements.

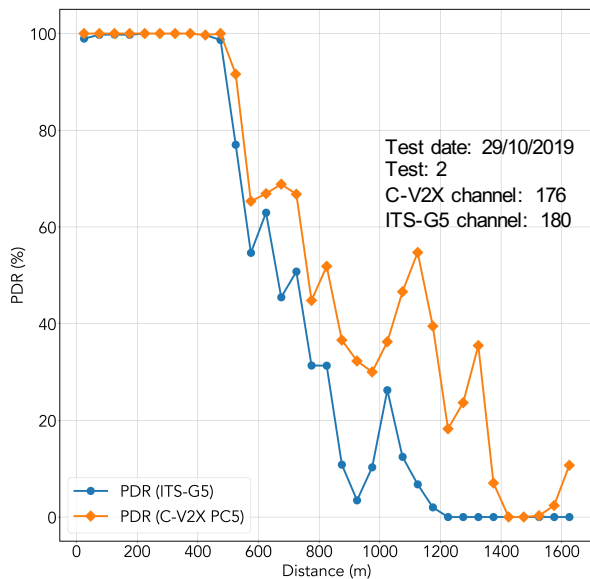

Fig. 17. PDR in relation to distance of ITS-G5 and C-V2X PC5 for vehicles driving at the same direction (V2V).

of ITS-G5 in low user density environments. SPS aims to ensure that the one-way latency will not exceed the threshold of $100ms$ that is required for ITS safety-related services [34]. This however depends on the user density that impacts the transmission collisions that might occur.

In Figure 15, it can be observed that for only a few packets the latency of ITS-G5 becomes rather high. This can be a result of several factors such as collisions between multiple transmissions or limitations at the hardware or firmware side of the commercial ITS-G5 module.

Table III shows selected percentile values of the average latency over all the tests that we have done during our last test campaign for both ITS-G5 and C-V2X PC5 technologies. As it can be seen from the table, 97% of the packets transmitted by ITS-G5 have a latency smaller than $5.5ms$, while for C-V2X and for the same percentile, the latency goes up to $37.84ms$. The latency for the 5th percentile is $1.43ms$ for ITS-G5 and $14.57ms$ for C-V2X PC5.

Finally, the Cohda MK5 devices are able to log the signal strength of the received messages via ITS-G5 technology. This information can be correlated to the performance KPIs, such as packet loss and latency and has been used for debugging

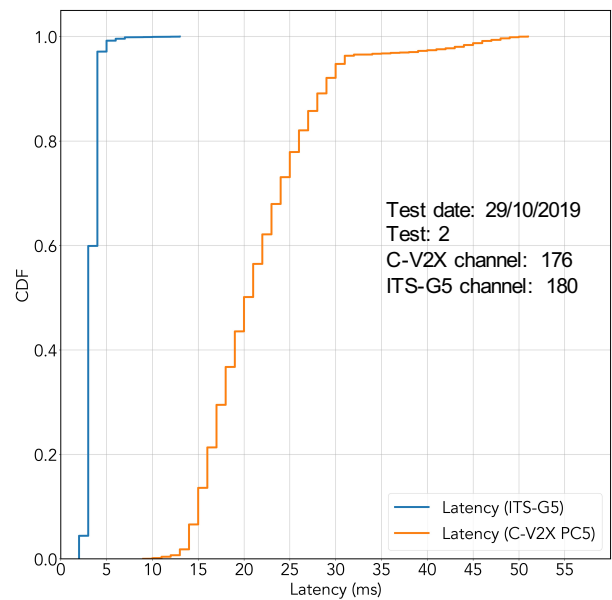

Fig. 18. End-to-end one-way latency between vehicles driving at the same direction for ITS-G5 and C-V2X PC5 (V2V).

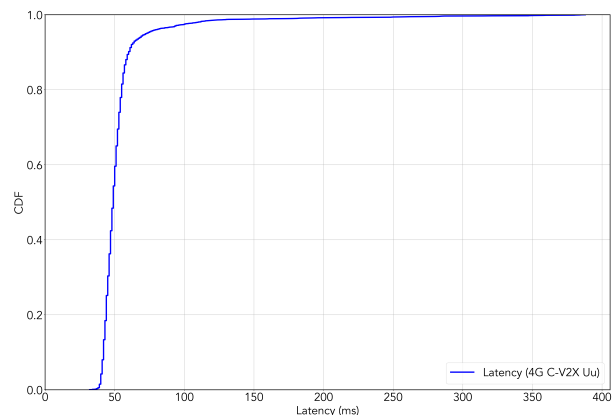

Fig. 19. End-to-end one-way latency between vehicles driving at the same direction for long-range 4G C-V2X Uu (V2V).

purposes and troubleshooting. In Figure 16, an example graph is shown with signal strength information of messages received at the Cohda MK5 device of the OBU and transmitted from RSU5 during a test at the E313 highway.

B. Performance evaluation of V2V

In Section V-B, it was described that the evaluation of the V2V communication has been divided into two scenarios, namely for vehicles moving at the same direction and for vehicles moving at the opposite direction. The V2V evaluation results of the two different scenarios are discussed in the following subsections. All the V2V tests have been performed on the trajectory shown in Figure 10 in both traffic directions.

1) *Vehicles driving at the same direction*: In the context of this scenario, initially, the vehicles drive in the proximity of each other. At a specific moment, the leading vehicle starts to accelerate until the distance between the two vehicles increases to $1500m$. At this point, the leading vehicle drives at

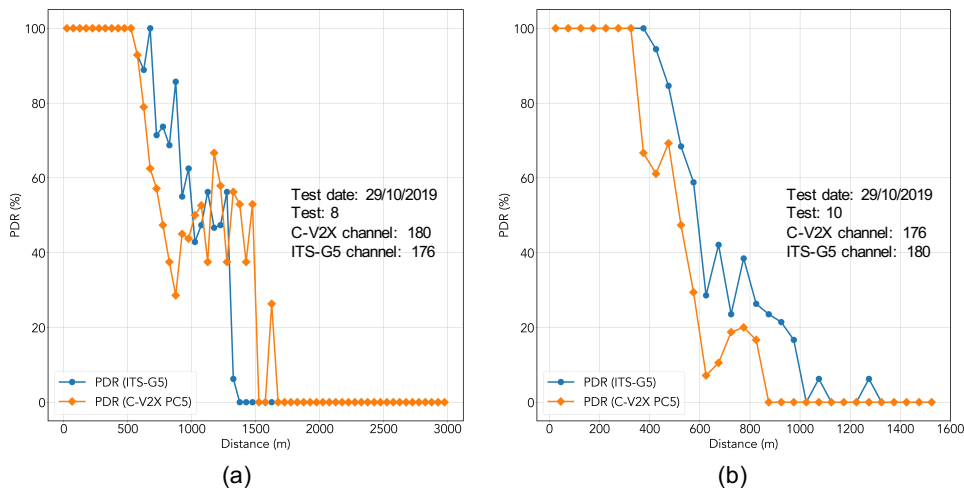

Fig. 20. PDR in relation to distance of ITS-G5 and C-V2X PC5 for vehicles driving at the opposite direction (V2V) and for different frequency channels: a) C-V2X PC5 channel 180 and ITS-G5 channel 176, b) C-V2X PC5 channel 176 and ITS-G5 channel 180.

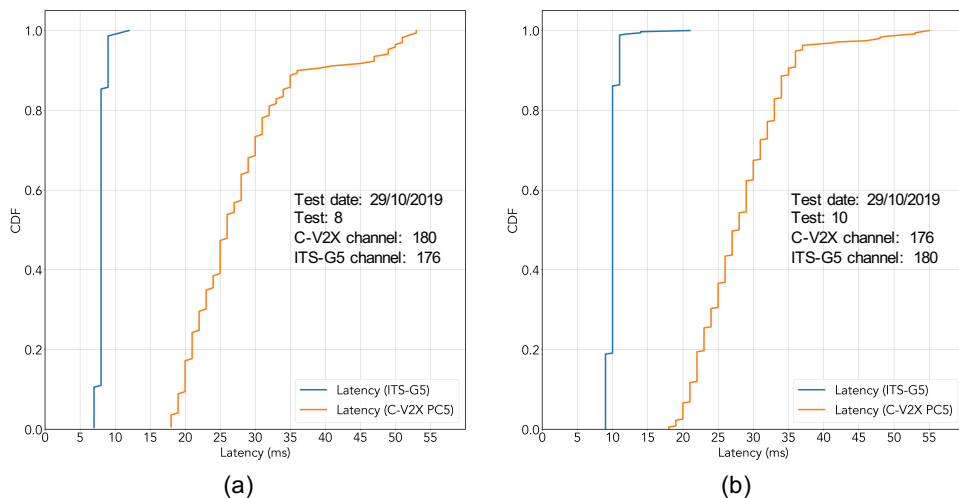

Fig. 21. End-to-end one-way latency between vehicles driving at the opposite direction (V2V) for C-V2X PC5 and ITS-G5 and for different frequency channels: a) C-V2X PC5 channel 180 and ITS-G5 channel 176, b) C-V2X PC5 channel 176 and ITS-G5 channel 180.

a constant speed, while the following vehicle accelerates until it reaches the vehicle ahead. This scenario has been evaluated for variable transmitted packet interval values (1, 5 and 10 packets per second) and for different frequency channels of the $5.9GHz$ ITS band.

Figure 17 presents the PDR in relation to distance of ITS-G5 and C-V2X PC5 for vehicles driving at the same direction. The horizontal axis shows the distance between the transmitting and the receiving vehicles in meters and for distance bins of $50m$ each. C-V2X PC5 is configured to operate in channel 176, while ITS-G5 in channel 180. Both technologies transmit CAM messages with a frequency of $10Hz$. As it is shown in the graph, both technologies start having some packet-losses at approximately the same distance of $480m$, with C-V2X PC5 performing slightly better than ITS-G5. However, for longer distances between the vehicles, C-V2X PC5 clearly outperforms ITS-G5, which has a more steep curve. For the graph of C-V2X PC5, it can be seen that for distance longer

than $1500m$ there are more than 10% of packets received. We believe that this is a result of signal reflections or the curvature of the highway.

Figure 18 shows the latency of the two technologies for the same scenario. Similar to the V2I evaluation, the latency of ITS-G5 is significantly lower than C-V2X PC5. This is because of the SPS that C-V2X PC5 uses. However, the latency of C-V2X PC5 is lower than the threshold of $100ms$ making the technology capable to guarantee the requirements of the ITS safety-related services.

Concurrently to the short-range V2V communication via C-V2X PC5 and ITS-G5, the long-range 4G C-V2X Uu communication link has been evaluated using the Message Queuing Telemetry Transport (MQTT) publish-subscribe protocol. The MQTT broker runs on the central server of the Smart Highway testbed and the OBUs (or the RSUs) can exchange messages with each other via long-range 4G using MQTT publisher and subscriber applications.

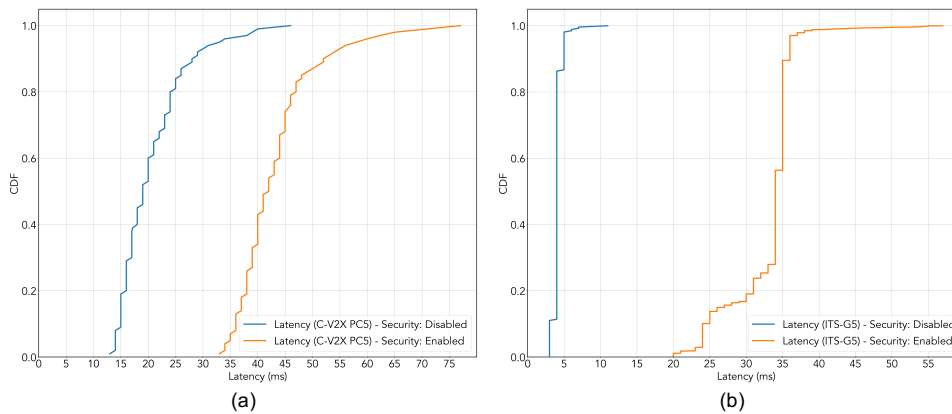

Fig. 22. End-to-end one-way latency for a) C-V2X PC5 with and without security and b) ITS-G5 with and without security.

TABLE IV
C-ITS STANDARDS USED AT THE BE AND NL-MRA TEST SITES

	Standards
ITS-G5 radio	ETSI EN 302 571 V2.1.1, ETSI EN 302 663 V1.2.1, ETSI TS 102 724 V1.1.1, ETSI TS 102 792 V1.2.1, ETSI TS 102 687 V1.1.1, ETSI TS 102 636-4-2 V1.1.1
C-V2X PC5 radio	3GPP Release 14
BTP/GeoNetworking	ETSI EN 302 636-4-1 V1.3.1, ETSI EN 302 636-5-1 V2.1.1, ETSI EN 302 931 V1.1.1, ETSI TS 102 636-6-1 V1.2.1, ETSI TS 103 097 V1.2.5
CAM/DENM	ETSI EN 302 637-2 V1.3.2, ETSI EN 302 637-3 V1.2.2, ETSI TS 102 894-2 V1.2.1, ETSI TS 103 301 V1.1.1
IVI	ETSI TS 103 301 V1.1.1, ISO/TS 19321:2015
Security	ETSI TS 10 097 v1.3.1 (BE), ETSI TS 103 097 v1.2.1 (NL-MRA)

Figure 19 shows the CDF graph of the E2E one-way latency between vehicles driving at the same direction for the long-range 4G C-V2X Uu link over MQTT. Similarly to the evaluation of the short-range communication, CAM messages are transmitted with a frequency of $10Hz$. As it can be observed, the latency of long-range communication over 4G fluctuates and may often exceed the threshold of $100ms$, questioning its suitability for V2X communication safety services and applications as it. This can be the result of several aspects such as limited network coverage, potential handovers between base stations, overloaded network close to hot-spots (e.g. train stations) or urban environments, etc. In that case, packets with latency higher than $100ms$ may be considered as packet-loss by the respective application.

The next part of the evaluation was to investigate the impact of the dynamically triggered DENM messages on the overall performance of the short-range technologies. Hence, the aforementioned tests have been repeated, with the difference that the vehicles always remain at the proximity of each other and that at specific locations of the highway, as described in Section V-B, the vehicles started dynamically transmitting DENM messages with a frequency of $10Hz$ in

parallel to the CAM messages, which are also transmitted with a frequency of $10Hz$. These DENM messages represent virtual events such as EEBL, RRW and SSV. For different tests, the DENM messages are of different size ranging between 300 and 600bytes. The experimentation results show that for both C-V2X PC5 and ITS-G5 technologies, the generation of DENM messages does not have an impact on the packet-loss and E2E one-way latency. However, in a more user-dense environment where many vehicles generate DENM messages concurrently, the performance of the technologies may be impacted as the technologies could have less available resources to transmit and additionally, collisions between different transmissions may occur more frequently.

2) *Vehicles driving at the opposite direction*: For the evaluation of these scenario, the vehicles start at opposite directions and drive towards each other at a constant speed. At a point in time, the vehicles meet, cross each other and continue driving in opposite directions, until again they are not in the proximity of each other. Similarly to the scenario of vehicles driving at the same direction, this scenario has been executed for variable packet interval values including 1, 5 and 10 packets per second and for different frequency channels of the $5.9GHz$ ITS band.

Figure 20 shows the PDR of ITS-G5 and C-V2X PC5 for two tests during which, both vehicles transmit CAM messages with a frequency of $10Hz$. The difference between the two tests is that for the first one (Figure 20(a)) C-V2X PC5 transmits in the ITS channel 180 and ITS-G5 transmits in the ITS channel 176, while for the second test (Figure 20(b)), the two technologies swap their frequency channels. As it is shown in Figure 20(a), both technologies have 100% PDR up to a distance of $500m$. Then, ITS-G5 offers better performance than C-V2X PC5 up to a distance of $1000m$. From that point, both technologies have a similar performance up to a distance of $1300m$, from where, C-V2X PC5 outperforms ITS-G5. In Figure 20(b) is shown that both technologies start facing packet-losses at shorter distance. During that test, ITS-G5 offers better performance than C-V2X PC5. These tests clearly showcase the unpredictable and dynamically changing environment of a highway that result in non-deterministic performance of the V2X technologies.

Figure 21 shows the CDF of the one-way E2E latency of

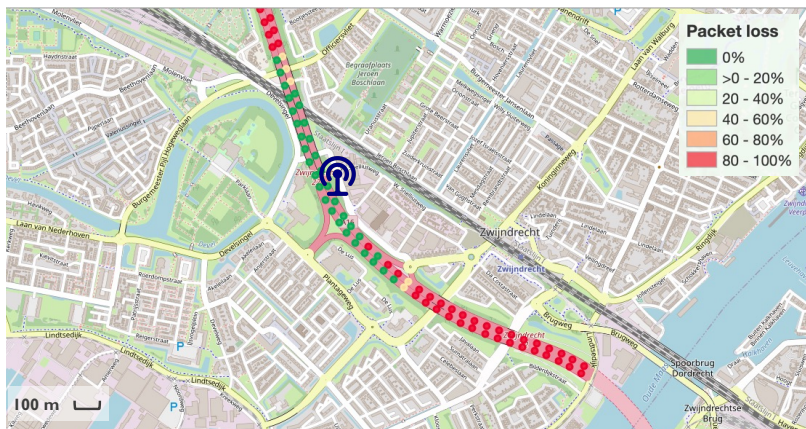

Fig. 23. Packet-loss between an MRA RSU and the Belgian OBU (V2I) for ITS-G5 (cross-country interoperability).

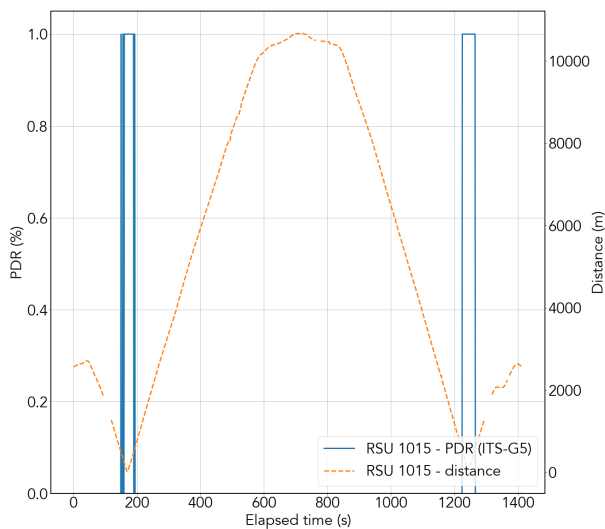

Fig. 24. PDR in relation to time and distance between an MRA RSU and the Belgian OBU (V2I) for ITS-G5 (cross-country interoperability).

the two technologies and for the two aforementioned tests. The two graphs show a quite similar performance between the two tests for both technologies. This is something to be expected since there were no other vehicles using the frequency channels.

C. Impact of security on V2X short-range technologies

This subsection discusses the impact of software-based security on C-V2X PC5 and ITS-G5. This evaluation has been done both for V2I and V2V communication links. The receiver is located always in the proximity of the transmitter, which transmits CAM messages with a frequency of 10Hz. Each one of the tests consists of two rounds. During the first round the security is disabled, while during the second round, software-based securing is enabled, using the ETSI v1.3 certificates.

Figure 22 a) shows the impact of security on the latency of C-V2X PC5, while Figure 22 b) show the impact of the latency of ITS-G5. As it can be seen, the average latency of C-V2X PC5 has been increased approximately by a factor of 2.2, when the security is enabled. Respectively, for ITS-G5,

the use of security increases the average latency approximately by a factor of 8. However, in every case, the latency remains at below the threshold of 100ms that is required for safety ITS services. The experimentation results show that the security does not have an impact on the PDR or packet-loss for both technologies.

D. Cross-country interoperability evaluation

During the cross-country test campaign, we have assessed the interoperability of the V2X technologies and C-ITS solutions that are supported in each of the test sites. The outcome of the tests provided insights in the compatibility issues that can be encountered at different levels, such as radio, networking, services and security level, when providing cross-country C-ITS services. A mismatch in the specification versions that are used can lead into unexpected and incorrect behaviour. In advance, we listed and identified the used standards and tried to match them as closely as possible. An overview is given in Table IV.

Furthermore, performance measurements have been conducted with a vehicle from the Belgian pilot at the MRA test site in the Netherlands. In Figure 23, the packet loss between one of the RSUs and the OBU is shown on a map during a drive test along the test trajectory. The RSU was transmitting CAM messages with a 1s periodicity via ITS-G5 technology on channel 180. The map shows that within a range of 250 – 300m the reception is 100%. Beyond that range, packet losses occur. This is also seen in Figure 24, which presents the PDR in function of the elapsed time. The distance between the vehicle and the RSU is also indicated. The plot shows the results from the vehicle driving back and forth in opposite directions. Thus, the distance is decreasing until it crosses the RSU. Then the distance is increasing again. The same pattern recurs on the returning path.

VII. CONCLUSIONS AND FUTURE WORK

This article has provided a fair evaluation of the different V2X communication technologies, using commercial equipment on top of a real-life highway environment. Both short-range C-V2X PC5 and ITS-G5, and long-range 4G C-V2X Uu

technologies have been evaluated for selected KPIs, including PDR, packet-loss, E2E one-way latency and signal strength. For the evaluation of the KPIs a series of configuration parameters have been considered, such as operating frequency channel in the 5.9 GHz band for the short-range technologies, packet transmission interval and packet size. The performance of the V2X technologies has been examined for a series of interesting test cases, including the performance of the V2I and V2V communication links, the impact assessment of security of software-based security on the short-range communication technologies and the performance of V2X technologies in cross-country infrastructures. By exploiting our in-house developed CAMINO V2X communication management framework, we were able to perform a fair evaluation of the technologies under exactly the same conditions, including transmission related parameters (simultaneous transmissions from the different V2X technologies, packet sizes, transmission intervals), highway environment conditions (traffic density, obstacles, street curvatures) and weather conditions. Each test has been repeated multiple times to ensure the reproducibility of the results.

According to the experimentation results, for the vast majority of the tests, C-V2X PC5 provides longer range than ITS-G5. On the other hand, ITS-G5 offers lower latency than C-V2X PC5, as a result of the channel access mechanisms that the two technologies use. Nevertheless, both technologies offer a latency below the threshold of 100ms required by ITS safety services and applications. The results also showed that the long-range communication link via 4G typically has no packet loss. However, sometimes very high latency is observed. Such latency values should be considered as packet-loss for the applications. Concerning the generation and transmission of DENM messages, it has been shown that they do not have an impact on the performance of the technologies in a non-dense environment. Finally, it was shown that when ETSI software-based security is enabled, the latency for both C-V2X PC5 and ITS-G5 is substantially increased, remaining however below the 100ms threshold. Scalability tests are required in order to draw more generic conclusion on how a high user density environment affects the E2E one-way latency performance of C-V2X PC5 and ITS-G5 and what the impact is of DENM messages on the performance of the technologies. However, such tests using real-hardware are very challenging as they require high numbers of RSUs and vehicles equipped with OBUs.

In the near future, we are planning to go a step further and evaluate the coexistence of the short-range V2X technologies, when they operate concurrently in the same channel of the 5.9GHz ITS band. This study will allow us to investigate the impact on the performance of the technologies based on related KPIs, such as spectrum occupancy of each technology, packet-loss, latency, etc. Moreover, it will provide insights into the technology behaviour under mutual interference conditions and will allow us to analyse interference solutions in real-life scenarios.

ACKNOWLEDGMENT

The research leading to this article has received funding from the CEF Program under grant agreement INEA/CEF/TRAN/M2016/1364071 (CONCORDA project) and the European H2020 Programs under grant agreement 952189 (5G-BLUEPRINT project), 825496 (5G-MOBIX project), 101016499 (DEDICAT-6G project).

The authors would like to thank Mr. Erik de Britto e Silva for his assistance during the execution of the experiments on the highway.

REFERENCES

- [1] European Commission. *Saving Lives: Boosting Car Safety in the EU. Reporting on the monitoring and assessment of advanced vehicle safety features, their cost effectiveness and feasibility for the review of the regulations on general vehicle safety and on the protection of pedestrians and other vulnerable road users.* Brussels, 2016.
- [2] European Commission. *Intelligent transport systems Cooperative, connected and automated mobility (CCAM)*, Available from: https://ec.europa.eu/transport/themes/its/c-its_en
- [3] Official Journal of the European Union. 2008/671/EC: Commission Decision of 5 August 2008 on the harmonized use of radio spectrum in the 5875-5905 MHz frequency band for safety-related applications of Intelligent Transport Systems (ITS).
- [4] CEPT/ECC 2015 ECC Decision (08)01. *The harmonized use of the 5875-5925 MHz frequency band for Intelligent Transport Systems.*
- [5] CEPT/ECC 2015 ECC Recommendation (08)01. *Use of the band 5855-5875 MHz for ITS.*
- [6] Costandoiu A., Leba, M. *Convergence of V2X communication systems and next generation networks.* Published in IOP Conference Series: Materials Science and Engineering, 2019.
- [7] IEEE 802.11p-2010. *IEEE Standard for Information technology—Local and metropolitan area networks— Specific requirements— Part 11: Wireless LAN Medium Access Control (MAC) and Physical Layer (PHY) Specifications Amendment 6: Wireless Access in Vehicular Environments.*
- [8] Molina-Masegosa, R. and Gozalvez, J. *LTE-V for sidelink 5G V2X vehicular communications: A new 5G technology for short-range vehicle-to-everything communications.* IEEE Vehicular Technology Magazine, 12(4), pp. 30-39, 2017.
- [9] Nabil, A., Kaur, K., Dietrich, C. and Marojevic, V. *Performance analysis of sensing-based semi-persistent scheduling in C-V2X networks.* In IEEE 88th vehicular technology conference (VTC-Fall) (pp. 1-5), 2018.
- [10] Z. MacHardy, A. Khan, K. Obana, S. Iwashina, *V2X Access Technologies: Regulation, Research, and Remaining Challenges.* In IEEE Communications Surveys & Tutorials, vol. 20, no. 3, pp. 1858-1877, thirdquarter 2018, doi: 10.1109/COMST.2018.2808444.
- [11] European Commission. *Framework for the Deployment of ITS Directive 2010/40/EU*, 2010.
- [12] ETSI EN 302 571 V2.1.1. *Harmonised Standard covering the essential requirements of article 3.2 of Directive 2014/53/EU*, 2017.
- [13] Marquez-Barja, J., Lannoo, B., Naudts, D., Braem, B., Donato, C., Maglogiannis, V., Mercelis, S., Berkvens, R., Hellinckx, P., Weyn, M. and Moerman, I. *Smart Highway: ITS-G5 and C2VX based testbed for vehicular communications in real environments enhanced by edge/cloud technologies.* Published in IEEE EuCNC, the European Conference on Networks and Communications, 2019.
- [14] Hafeez, K.A., Zhao, L., Ma, B. and Mark, J.W. *Performance analysis and enhancement of the DSRC for VANET's safety applications.* IEEE Transactions on Vehicular Technology, 62(7), pp. 3069-3083, 2013.
- [15] Bazzi, A., Masini, B.M., Zanella, A. and Thibault, I. *On the performance of IEEE 802.11 p and LTE-V2V for the cooperative awareness of connected vehicles.* IEEE Transactions on Vehicular Technology, 66(11), pp. 10419-10432, 2017.
- [16] Mannoni, V., Berg, V., Sesia, S. and Perraud, E. *A comparison of the V2X communication systems: ITS-G5 and C-V2X.* In 2019 IEEE 89th Vehicular Technology Conference (VTC2019-Spring), pp. 1-5, 2019.
- [17] Nabil, A., Kaur, K., Dietrich, C. and Marojevic, V. *Performance analysis of sensing-based semi-persistent scheduling in C-V2X networks.* In 2018 IEEE 88th vehicular technology conference (VTC-Fall), pp. 1-5, 2018.

- [18] Lin, J.C., Lin, C.S., Liang, C.N. and Chen, B.C. *Wireless communication performance based on IEEE 802.11 p R2V field trials*. *IEEE Communications Magazine*, 50(5), pp. 184-191, 2012.
- [19] Teixeira, F.A., e Silva, V.F., Leoni, J.L., Macedo, D.F. and Nogueira, J.M. *Vehicular networks using the IEEE 802.11 p standard: An experimental analysis*. In *Vehicular Communications*, 1(2), pp. 91-96, 2014.
- [20] Miao, L., Virtusio, J.J. and Hua, K.L. *PC5-Based Cellular-V2X Evolution and Deployment*. *Sensors*, 21(3), p. 843, 2021.
- [21] Fan, Y., Liu, L., Dong, S., Zhuang, L., Qiu, J., Cai, C. and Song, M. *Network Performance Test and Analysis of LTE-V2X in Industrial Park Scenario*. *Wireless Communications and Mobile Computing*, 2020.
- [22] Botte, M., Pariota, L., D'Acerno, L. and Bifulco, G.N. *An overview of cooperative driving in the European Union: Policies and practices*. *Electronics*, 8(6), pp. 616, 2019.
- [23] ETSI EN 302 637-2 V1.3.1. *Intelligent Transport Systems (ITS); Vehicular Communications; Basic Set of Applications; Part 2: Specification of Cooperative Awareness Basic Service*. 2014-09.
- [24] ETSI EN 302 637-3 V1.2.1. *Intelligent Transport Systems (ITS); Vehicular Communications; Basic Set of Applications; Part 3: Specifications of Decentralized Environmental Notification Basic Service*. 2014-09.
- [25] ISO/TS 19321:2015. *Intelligent transport systems — Cooperative ITS — Dictionary of in-vehicle information (IVI) data structures*. 2015-04.
- [26] InterCor Milestone 13 - Pilot evaluation report. Available from: https://intercor-project.eu/wp-content/uploads/sites/15/2020/03/InterCor_M13-Pilot-Evaluation_v1.0_INEA.pdf.
- [27] Amsterdam Practical Trial. <https://www.praktijkproefamsterdam.nl/en/about-amsterdam-practical-trial>.
- [28] Mills, D.L. Internet time synchronization: The network time protocol. *IEEE Trans. Commun.*, 39, 1482–1493, 1991.
- [29] Netten, B., Wedemeijer, H. *InterCor specification of log data and formats*, October 2019. Available from: <https://ada1.tno.nl/logformats/>.
- [30] Naudts, D., Maglogiannis, V., Hadiwardoyo, S., Van den Akker, D., Vanneste, S., Mercelis, S., Hellinckx, P., Lannoo, B., Marquez-Barja, J., Moerman, I. *Vehicular Communication Management Framework: A Flexible Hybrid Connectivity Platform for CCAM Services*. *MDPI Future Internet*, 13(3), pp. 81, 2021.
- [31] Vanneste, S., de Hoog, J., Huybrechts, T., Bosmans, S., Eyckerman, R., Sharif, M., Mercelis, S., Hellinckx, P. *Distributed Uniform Streaming Framework: An Elastic Fog Computing Platform for Event Stream Processing and Platform Transparency*. *Future Internet* 2019, 11, 158.
- [32] Escript. *V2X: Hybrid communication, homogeneous IT security*, 2018. Available from: <https://www.escript.com/en/news-events/hybrid-v2x-communication>.
- [33] CEF CONCORDA project. Available from: <https://connectedautomateddriving.eu/project/concorda/>.
- [34] Zheng, K., Zheng, Q., Chatzimisios, P., Xiang, W., Zhou, Y. *Heterogeneous vehicular networking: A survey on architecture, challenges, and solutions*. *IEEE communications surveys & tutorials*, 17(4), pp. 2377-2396, 2015.



Vasilis Maglogiannis received his M.Eng. degree in Computer Engineering and M.Sc. degree in Science and Technology of Computers, Telecommunications and Networks from the University of Thessaly, Greece, in 2012 and 2014, respectively. In 2018, he obtained his Ph.D. degree in Computer Science Engineering from the Department of Information Technology, Ghent University, Belgium. From January 2019 to March 2021, he has worked as Post-doctoral Researcher at the IDLab, Ghent University, in collaboration with imec. Since April 2021, he has

been working as Senior Researcher at imec - IDLab Ghent University. His research interests include mobile and wireless networks, 5G and beyond, LTE, IEEE 802.11, Cooperative Intelligent Transport Systems (C-ITS), real-time software defined radio, and wireless sensor networks. He has experience in working on several bilateral, consultancy, national, and European research and development projects, in collaboration with academic and industrial partners.



Dries Naudts received the master's degree in computer science from Ghent University, Belgium, in 2001. After his studies, he started working as a Software Engineer in the private sector. In April 2005, he joined the Internet and Data Lab (ID-Lab) research group of the Ghent University, where he is currently working as a Senior Researcher. Since 2009, he has been affiliated with imec. He is mainly involved in research on broadband mobile and wireless communication. His research interests include advanced network architecture, mobile wireless networks, 4G, 5G, C-ITS, V2X, evolved packet core, IEEE 802.11, ad hoc and mesh networking, IPv6, and wireless testbed development. He is working on several bilateral/consultancy, national, and European research and development projects in close collaboration with other academic and industrial partners.



Seilendria Hadiwardoyo is a Postdoc at UAntwerpen and R&D Project Leader at IMEC with IDLab research group, Belgium. He received his B.Eng degree from the University of Indonesia and his Pre-Master's Diploma from the University of Lille, France. Dr. Hadiwardoyo obtained his M.S degree from the University of South Brittany, France and his Predoctoral Diploma from the University of Minho, Portugal. His PhD thesis on vehicular communications was defended at the Polytechnic University of Valencia, Spain. Previously, he has done research on telecommunications for transportation at various institutes in France (IFSTTAR), Portugal (CAIG), Japan (NII), Russia (SPbETU LETI), and Belgium (ULB). He has been involved in various national and international (H2020) R&D projects related to Connected and Autonomous Mobility. His research interests include ad-hoc and V2X networks, mobile applications, and implementation of Intelligent Transport Systems (ITS).



Daniel van den Akker obtained his Masters degree in Computer Science in June 2009 at the University of Antwerp and joined the 'Performance Analysis of Telecommunication Systems' (PATS) research group shortly afterwards. In September 2020 he obtained his PhD in Computer Science and he is currently a member of the 'Internet & Data Lab' (IDLab) research group at the University of Antwerp. His main research interests include wireless networks, Low-Power sensor networks, IoT-communication and next-gen network- and testbed-

infrastructures. In addition he has been involved in numerous international research projects related to wireless communication and he is one of the developers and system administrators of the 'Citylab' testbed for wireless communication and the 'Smart Highway' testbed for V2X-communication.



Johann Marquez-Barja is a Professor at University of Antwerp, as well as a Professor in IMEC, Belgium. He is leading the Wireless Cluster at IDLab/imec Antwerp, and he is the Program Director of the IoT Initiative (UAntwerp, Ghent University and Free University of Brussels). He was and is involved in several European research projects such as CREW, FORGE, WiSHFUL, Fed4FIRE/FAVORITE, Fed4FIRE+, eWINE, CONCORDA, 5G-CARMEN, FLEXNET, FUTEBOL (Technical Coordinator), 5G-Mobix, PRO-

TEGO, InterConnect, Dedicat-6G, Daemon, Vital-5G and 5G-Blueprint (Technical Coordinator) projects. He is a member of ACM, and a Senior member of the IEEE Communications Society, IEEE Vehicular Technology Society, and IEEE Education Society where he participates in the board of the Standards Committee. His main research interests are: 5G advanced architectures including edge computing; flexible and programmable future end-to-end networks; IoT communications and applications. He is also interested in vehicular communications, mobility, and smart cities deployments.



Ingrid Moerman (Member, IEEE) received the degree in electrical engineering and the Ph.D. degree from Ghent University, in 1987 and 1992, respectively. She became a part-time Professor at Ghent University in 2000. She is currently a Staff Member with IDLab, a core research group of imec with research activities embedded in Ghent University and the University of Antwerp. She is coordinating the research activities on mobile and wireless networking at Ghent University, where she is leading a research team of more than 30 members. She is

also a Program Manager of the "Deterministic Networking" track at imec and in this role she coordinates research activities on end-to-end wired/wireless networking solutions driven by time-critical applications that have to meet strict QoS requirements in terms of throughput, latency bounds and dependability in smart application areas such as Industry 4.0, vehicular networks, and professional entertainment. Her research interests include cooperative and intelligent radio networks, real-time software defined radio, time-sensitive networks, dynamic spectrum sharing, coexistence across heterogeneous wireless networks, vehicular networks, open-source prototyping platforms, software tools for programmable networks, next generation wireless networks (5G/6G), and experimentally supported research. She has a longstanding experience in running and coordinating national and EU research funded projects. At the international level, she was leading team SCATTER, consisting of researchers from IMEC-IDLab and Rutgers University, USA, in the DARPA Spectrum Collaboration Challenge (SC2). The double prize winning SCATTER team was one of the ten finalists at the DARPA SC2 championship event organized at Mobile World Congress in LA (October 2019).