



# Wearable and implantable artificial kidney devices for end-stage kidney disease treatment: Current status and review

Thomas Groth<sup>1,2</sup>  | Bernd G. Stegmayr<sup>3</sup> | Stephen R. Ash<sup>4</sup> | Janna Kuchinka<sup>1</sup> | Fokko P. Wieringa<sup>5,6,7</sup>  | William H. Fissell<sup>8</sup> | Shuvo Roy<sup>9</sup>

<sup>1</sup>Department Biomedical Materials, Institute of Pharmacy, Martin Luther University Halle-Wittenberg, Halle (Saale), Germany

<sup>2</sup>International Federation for Artificial Organs, Painesville, Ohio, USA

<sup>3</sup>Department of Public Health and Clinical Medicine, Umea University, Umea, Sweden

<sup>4</sup>HemoCleanse Technologies, Lafayette, Indiana, USA

<sup>5</sup>IMEC, Eindhoven, The Netherlands

<sup>6</sup>Department of Nephrology, University Medical Centre, Utrecht, The Netherlands

<sup>7</sup>European Kidney Health Alliance, WG3 “Breakthrough Innovation”, Brussels, Belgium

<sup>8</sup>Vanderbilt University Medical Center, Nashville, Tennessee, USA

<sup>9</sup>University of California, California, San Francisco, USA

## Correspondence

Thomas Groth, Department Biomedical Materials, Institute of Pharmacy, Martin Luther University Halle-Wittenberg, 06120 Halle (Saale), Germany.  
Email: [thomas.groth@outlook.de](mailto:thomas.groth@outlook.de)

## Funding information

Deutsche Forschungsgemeinschaft, Grant/Award Number: Gr1290/13-1; Nierstichting; Njurforeningen Vasterbotten, Sweden

## Abstract

**Background:** Chronic kidney disease (CKD) is a major cause of early death worldwide. By 2030, 14.5 million people will have end-stage kidney disease (ESKD, or CKD stage 5), yet only 5.4 million will receive kidney replacement therapy (KRT) due to economic, social, and political factors. Even for those who are offered KRT by various means of dialysis, the life expectancy remains far too low.

**Observation:** Researchers from different fields of artificial organs collaborate to overcome the challenges of creating products such as Wearable and/or Implantable Artificial Kidneys capable of providing long-term effective physiologic kidney functions such as removal of uremic toxins, electrolyte homeostasis, and fluid regulation. A focus should be to develop easily accessible, safe, and inexpensive KRT options that enable a good quality of life and will also be available for patients in less-developed regions of the world.

**Conclusions:** Hence, it is required to discuss some of the limits and burdens of transplantation and different techniques of dialysis, including those performed at home. Furthermore, hurdles must be considered and overcome to develop wearable and implantable artificial kidney devices that can help to improve the quality of life and life expectancy of patients with CKD.

## KEYWORDS

chronic kidney disease, kidney replacement therapies, wearable and implantable artificial kidneys



## 1 | INTRODUCTION

When kidney function decreases below a glomerular filtration rate (GFR) of  $10\text{ ml}/1.73\text{ m}^2$  a consideration has to be taken on how to compensate for the lost kidney function to avoid death by uremia.<sup>1</sup> Such a decrease in kidney failure can either appear acute within a few hours<sup>2</sup> or slowly over many years of suffering from progressively worsening CKD.<sup>1</sup>

The most effective kidney replacement therapy (KRT) is a kidney transplant. Besides the shortage of donor kidneys, transplantation programs include expensive immunosuppressive therapy, which is sensitive to individual patient adherence and causes increased risk of cancers and infections, plus decreased effectiveness of vaccinations (e.g., for COVID-19). Limited transplant survival<sup>3</sup> may require repeated transplants during a patient's lifetime. However, donor organs are scarce, the most common therapy is some form of maintenance dialysis.

KRTs are expensive and hence they are not available for all patients. In the less wealthy regions of the world, yearly more than 2 million people die due to restricted or no access to KRT.<sup>4</sup> In 2016, CKD was the 16th leading cause of early death worldwide, while it is expected to rise to position 5 by 2040.<sup>5</sup> By 2030, 14.5 million people will have end-stage kidney disease (ESKD), yet only 5.4 million will receive KRT due to economic and other constraints. Although kidney disease is not among the 4 non-communicable diseases (NCDs) specifically targeted by the World Health Organization (WHO) action plans (2013–2020), Appendix 1 of the WHO action plan does recommend a comprehensive response to the prevention and control of NCDs taking into account “*synergies between the four major communicable diseases and other diseases, including kidney disease.*”<sup>6</sup> For example, to address the financial cost of treatment, governments have to pay for dialysis for patients who lack commercial insurance plans.<sup>7</sup>

However, despite having a highly developed medical service provider network, the life expectancies of dialysis patients in the European Union and the United States are still far too low. A not so recent, but unfortunately still quite accurate, review article on the progress in routine dialysis therapy stated that technological innovations have not been translated into better survival of patients.<sup>8</sup> Therefore in the United States, the American Society for Nephrology (ASN), the Food and Drug Administration (FDA), and patient organizations such as the American Association of Kidney Patients (AAKP) and Home Dialyzers United (HDU), have joined forces within the Kidney Health Initiative (KHI) in a call for disruptive innovation on treatment modalities evolving from stationary to wearable or even implantable artificial kidney products to improve

quality of life with improved survival of patients, in which effort the European Kidney Health Alliance (EKHA) also joined.<sup>9</sup> New candidate technologies have to address the numerous challenges of creating Wearable (WAK) or Implantable Artificial Kidney (IAK) capable of providing long-term and effective physiologic kidney functions, such as removal of uremic toxins, electrolyte homeostasis, and fluid regulation.<sup>9,10</sup> A focus should be to develop easily accessible, safe, and inexpensive KRT options that enable a good quality of life (QoL) that will also be available and affordable for patients with CKD in less developed regions of the world.

This paper will first present some of the limitations and burdens of present KRTs (Table 1) and also provide a brief survey on techniques to perform dialysis at home, before dealing with some of the future options of wearable and implantable artificial kidney devices. This paper intends to offer researchers on artificial organs outside the kidney field an overview of the status and challenges within the kidney field, hoping that they may become inspired to trigger cross-fertilizations between the various subfields of wearable and implantable artificial organs.

## 2 | ISSUES WITH CURRENT KRT APPROACHES

### 2.1 | Intermittent hemodialysis

Economical limitations result in repetitive high-efficacy short-duration procedures rinsing the blood from uremic toxins and quickly removing accumulated fluid load using an extracorporeal circuit, incorporating a dialyzer. Most hemodialysis types are performed intermittently, such as 4 hours/session performed 2–4 times/week. Between treatment sessions, uremic toxins, and excess fluid load re-accumulate.

Intermittent hemodialysis (iHD) performed at an institution is the most widely used type of dialysis worldwide, but due to the intermittent nature of hemodialysis, it is unable to remove many uremic toxins including substances such as phosphorus in sufficient quantities because of their large molecular size, their protein-bound nature, or their sequestration in underperfused tissue beds. Transmembrane pressure-driven fluid removal—ultrafiltration—may be done separately or combined during iHD. This procedure can induce episodes of hypovolemic hypotension that are very common in dialysis. Such hypotension is associated with regional heart wall motion abnormalities and the typical pathognomonic cardiac lesion of dialysis: left ventricular hypertrophy.

Hemofiltration (HF) is a dialysis technique using a high-flux membrane and only convective transport across



TABLE 1 Various types of cleansing concepts for the treatment of uremic patients

Technical term	Cleansing concept	Blood access	Mechanism	Location
Kidney transplantation	Acts as a replacement for a normal kidney	No extra-corporal blood circuit: Internal connection to the iliac or pelvic artery and vein	Full endocrine and toxin elimination; Most require immune suppression	Surgically initiated. Furthermore, mostly self-care Out-patient visits
<b>Extracorporeal bloodline dialysis concepts</b>				
Hemodialysis	Dialyzer: Synthetic semipermeable dialysis membranes	AV-fistula, AV-graft, AV-shunt, Central dialysis catheter	Diffusion	In dialysis unit, Self-care unit Home care. Relocation/carry on
Ultrafiltration	Dialyzer: Synthetic semipermeable dialysis membranes with the aim to remove water	AV-fistula, AV-graft, AV-shunt, Central dialysis catheter	Convection	In dialysis unit, Self-care unit Home care Relocation/carry on
Hemofiltration	Dialyzer: Synthetic semipermeable dialysis membranes	AV-fistula, AV-graft, AV-shunt, Central dialysis catheter	Convection	In dialysis unit, Self-care unit Home care Relocation/carry on
Hemodiafiltration	Dialyzer: Synthetic semipermeable dialysis membranes	AV-fistula, AV-graft, AV-shunt, Central dialysis catheter	Diffusion and convection	In dialysis unit, Self-care unit Home care Relocation/carry on
Hemoperfusion	Sorption of molecules to binding material either using dialyzer: Synthetic semipermeable dialysis membranes with sorptive abilities or sorption columns	AV-fistula, AV-graft, AV-shunt, Central dialysis catheter	Sorption	In dialysis unit
<b>Intraabdominal dialysis concepts</b>				
Peritoneal dialysis	Natural membrane: Peritoneal cavity including organ and intestinal mesothelial cell layer	No blood access needed. Instead uses a permanently fixed and partly intraabdominal catheter	Diffusion and convection	Home self-care, carry on; In dialysis unit, Nursery home

the dialysis membrane. HF requires infusion-graded replacement fluid volumes of about 25 L/session.<sup>11</sup>

Hemodiafiltration (HDF) is a combination of iHD and HF. The technique is frequently available in modern dialysis devices, although not applied in all countries. Nowadays HDF devices can prepare ultrapure sterile hemofiltration fluid, although regulatory issues exist within some countries. Balancing of electrolytes—including potassium and calcium—enables individualization of dialysates as well as individualized anticoagulation regimes (usually heparin or low molecular weight heparin).

However, comparative studies show no significant differences in survival for iHD versus HDF.<sup>12</sup>

Hemoperfusion is an adsorption technique. It can be performed to remove specific toxins or drugs ingested by accident or in suicidal attempts. Usually, this is performed by having blood passing through a column of active charcoal.<sup>13</sup>

To increase efficacy, this technique can be combined online with iHD.

It also improves the removal of middle molecular weight molecules during dialysis with clinical benefits.<sup>14–16</sup> By adding absorption techniques to the HD concept, various metabolites, cytokines, and toxins may be lowered, but the efficiency is under discussion.<sup>17</sup>

All the above-listed intermittent procedures induce several side effects of various levels of severity. One general measure of side-effect severity is the time to recover (rebound effect) after iHD which can vary from instantaneously to over 12 h.<sup>18</sup> While intermittent dialysis with short duration sessions causes more rebound of toxins, intermittent dialysis with longer duration (nocturnal) sessions causes fewer side effects (when both have the same urea clearance). Nevertheless, despite some incremental improvements in dialyzer membranes and dialysis techniques, long-term survival with iHD remained



short: approximately 4–5 years for those in Europe and North America and 8 years for those in Japan.<sup>19,20</sup>

A list of various common types of cleansing methods of accumulated substances in uremic patients is shown in Table 1.

To route blood through the extracorporeal circuit (ECC) and enable hemodialysis, the procedure requires well-functioning vascular access.<sup>21,22</sup> Lower arm arteriovenous fistulas and grafts are preferred to tunneled catheters. Tunneled catheters are a portal for infection into the endovascular system. Endocarditis and spinal osteomyelitis are endemic among the hemodialysis population in the United States. Arteriovenous grafts and fistulas are much less likely to be infected, but primary and secondary patency rates are disappointing, and repeated surgeries and procedures punctuate the lives of patients depending on dialysis.

The single-use ECC contains needles, bloodlines, and dialyzers that all contribute to blood membrane interactions such as “first use syndrome”, activation of coagulation, platelets, and leukocytes. In addition, microbubbles of air and microemboli may be incorporated into the blood returned to the patient, which can damage the organs of the patient.<sup>23,24</sup>

## 2.2 | Intraperitoneal dialysis concepts

Peritoneal dialysis (PD) is a technique that uses the mesothelial cell membrane layer as a dialysis membrane, using the natural vascular structure of the abdominal membrane as the blood circuit. This removes the need for an ECC for blood.

Dialysis fluid is brought into the abdominal cavity and waste substances diffuse through the abdominal membrane 8–24 hours/daily. In some areas, PD is used by up to 50% of patients. It saves vascular access options for later use and enables patients to perform dialysis by themselves at home.

Approximately 2 L of sterile iso-osmotic or hypertonic fluid is instilled through a permanently placed catheter (usually single lumen Tenckhoff type). The catheter is usually located in a subcutaneous tunnel exiting lateral and inferior to the umbilical area with an entrance into the peritoneal cavity. The insertion techniques differ and usually, a break-in period is necessary.<sup>25,26</sup> With a three purse-string suture technique for catheter placement together with a surgical girdle and antibiotic prophylaxis no break in time is necessary while the use of a self-locating catheter limits invagination into the omentum.<sup>27,28</sup>

Drainage and refilling of PD fluid are typically performed 4–5 times/day (manual procedure) or 3–15 times/day (with an automatic cyler, usually overnight).<sup>29</sup> The choice of osmotic strength of glucose or icodextrin in the fluid decides the efficacy of ultrafiltration while the combination of the effective surface area of intraabdominal

space, exchange volumes, and exchange frequency limit dialysis efficacy.

The main limits of PD are access problems, peritonitis, insufficient dialysis efficacy, and the logistics of PD-fluid delivery (approx. 10 L/every day). The yearly event rate for the first peritonitis is approximately 0.30; mostly by gram-positive bacteria (66%) while polymicrobial infections represented 7.5%.<sup>30</sup> Access problems may need repeated interventions. Bacteria and subsequent infections can enter through the catheter lumen during bag exchanges. Bacteria can also ingress along the outside of the catheter, through the subcutaneous tunnel into the peritoneal cavity.<sup>31</sup> A subsequent peritonitis, although treated with intraabdominal antibiotics, can cause intraabdominal fibrosis, angiogenesis, and hyalinizing vasculopathy which may affect peritoneal solute transfer rate and ultrafiltration, thus impairing clinical outcomes.<sup>32</sup> Long-term exposure to dialysis fluids containing glucose as osmotic active substances for fluid removal, bears the risk of sclerosis, and decreasing permeability of the peritoneal membrane, which in rare cases progresses to encapsulating peritoneal sclerosis.<sup>32</sup> Partial substitution with dialysate containing glucose polymers like icodextrin (Extraneal™) and amino acids limit glucose exposure and can reduce the negative effects of glucose exposure.<sup>33,34</sup>

In-between filling and flushing moments, PD patients have the freedom to move around. For travelers on PD, dialysis bags need to be packed into luggage or delivered (booked in advance) to the planned location. Automatic cyclers typically are portable devices. These are still expensive techniques, mainly due to the large, required dialysis fluid volume.

As a summary of the previous paragraphs, one can state that PD as well as self-HD at home both require a daily commitment and may be a stressful option. For a large proportion of patients, these techniques are still too difficult to use, they require access to ultrapure water and they are expensive. Future low-cost options should be highly portable, wearable, or even implantable artificial kidneys that need limited commitment to enable KRT at home, during daily activities, or fully continuous. A lowered efficacy could be compensated by more frequently or even continuously performed treatment, more like a normal kidney does. Changing of sorbents and charging of batteries could be performed intermittently.

## 2.3 | Single-pass devices versus dialysate-regenerating devices

Pure water is an essential ingredient to produce the fluids for PD, HD, HF, and HDF. Making 1 L of pure water typically requires 3 to 5 L of good quality potable water.



The present installed base of dialysis devices are almost entirely so-called “single-pass” machines in which dialysate fluid is discarded as waste after a *single pass through the dialyzer or abdomen* (hence the term “spent” dialysate). Their water consumption is, therefore, very large and, in some settings, prohibitive. Hemodialysis, e.g., can exceed 150 L of dialysate during a 4-h session, repeated 3 times/week.

In contrast, *dialysate-regenerating* devices recondition “spent” dialysis fluid so that it can *repeatedly pass the dialyzer in a closed loop*. This results in much less consumption of water (no fixed plumbing needed) and electricity (less fluid to heat), which in turn creates engineering opportunities for the miniaturization of dialysis devices to leverage “freedom-to-move.” Dialysis at home, or while staying elsewhere, in combination with more treatment scheduling flexibility, offers potential for cost savings and increased quality of life.

## 2.4 | Dialysate-regeneration and oral sorbents to leverage “freedom to move”

Dialysate regeneration can be achieved in several ways. The most widely applied methods are sorbent-based, assisted by the enzyme urease to decompose urea, but also electro-oxidation and photo-catalytic oxidation of urea are in development. Activated charcoal often is applied as an additional “broad range” sorbent.

The application of sorbent-based dialysate regeneration technology can be examined in the context of over six million clinical treatments.<sup>35</sup> A historical Sorbent-based example is represented by the Sorb™ column of the

Redy™ machine which demonstrated that complete regeneration of dialysate required only four chemically active layers: activated charcoal sorbent, immobilized urease enzyme, a cation exchanger, and an anion exchanger. The charcoal sorbent was highly effective in the removal of all organic uremic toxins, and even protein-bound uremic toxins such as para-cresol sulfate and indoxyl-sulfate but also  $\text{HPO}_4^{2-}$ . These are compounds that produce major symptoms of chronic uremia.<sup>36,37</sup> The Redy™ cartridge absorbed  $\text{K}^+$  and  $\text{Ca}^{2+}$  (which thus needed replenishment via a concentrate) and bound the  $\text{NH}_4^+$  released by urease enzymatic decomposition of urea.

The AAMI has published a Technical Information Report on methods to regenerate dialysis fluid using sorbents<sup>35</sup> as shown in Figure 1.

Sorbents may also be used orally, as auxiliary therapy to reduce retention and peak levels of toxic substances such as phosphate, potassium, and hydrogen. This may lower the required frequency of hemodialysis sessions.

For decades, oral sorbents have been used to decrease serum phosphate in patients with CKD and ESKD. Most work by anion exchange of phosphate for chloride or carbonate ions and some work by precipitation of phosphate with calcium, magnesium, lanthanum, or iron ions.<sup>38</sup> The removal of phosphate is reasonably effective in combination with strict dietary intake limitations, but most patients on hemodialysis still have high phosphate levels in spite of the intake of large amounts of binders.

Sodium bicarbonate is an effective binder of hydrogen ions in the gut and will help to correct uremic acidosis.<sup>39,40</sup> However, for each meq of  $\text{H}^+$  removed the sodium bicarbonate releases one meq of  $\text{Na}^+$ , as does

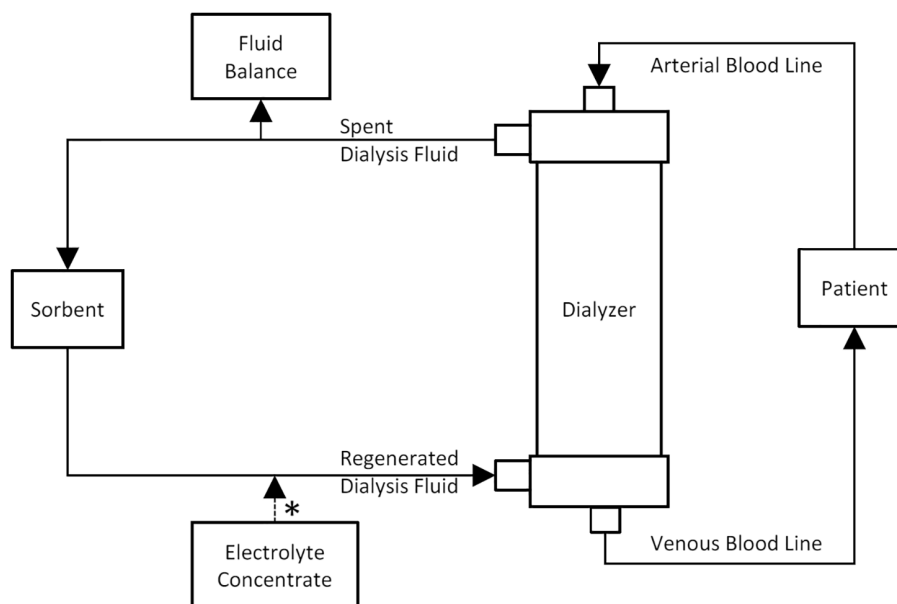

FIGURE 1 Sorbent-based regenerative hemodialysis system (simplified general principle). Reprinted with permission from Ref. [35]





sodium citrate. The  $\text{Na}^+$  release contributes to excess  $\text{Na}^+$  in the body, increasing the risk of edema or fluid overload. There is no effective oral sorbent for  $\text{Na}^+$ . Veverimer is a polymeric buffer that absorbs  $\text{H}^+$  directly, without releasing  $\text{Na}^+$  or other cations.<sup>41</sup> The medication is currently still in clinical trials. Oral potassium binders have been improved significantly with the market introduction of patiromer and sodium zirconium cyclosilicate (SZC).<sup>42-44</sup> Previously sodium polystyrene sulfonate (SPSS) was used to treat hyperkalemia but was not highly effective, it often was given with an osmotic laxative, which had occasional adverse effects on the gut.<sup>45</sup> The newer agents are more effective, better tolerated (even in long-term use) and have been shown to be able to help control serum potassium levels between dialysis therapies.<sup>46,47</sup> For example, Patiromer exchanges  $\text{Ca}^{++}$  for  $\text{K}^+$ , and SZC exchanges mostly  $\text{H}^+$  but also some  $\text{Na}^+$  for  $\text{K}^+$ .

Ash and coworkers are developing an inorganic oral sorbent mixture with the potential to remove five uremic toxins from the gut:  $\text{Na}^+$ ,  $\text{K}^+$ ,  $\text{Phos}^-$ ,  $\text{H}^+$ , and  $\text{NH}_4^+$  (thus also promoting the removal of urea in the gut). Their sorbent is a mixture of an  $\text{H}^+$ -loaded cation exchanger and an  $\text{OH}^-$ -loaded anion exchanger. In vitro studies are promising, and animal trials are ongoing.<sup>48</sup> If such a mixture will be successful, then hemodialysis would still be necessary for the removal of organic toxins and middle molecules in patients with ESRD, but

dialysate regeneration would be much simpler, using activated charcoal or similar material in a column (see Figure 1 as well).

## 2.5 | (Trans)portable machines for home dialysis and traveling

As an alternative to treatments in dialysis centers, various (trans)portable devices have been developed which topic has been reviewed recently.<sup>49-51</sup>

In order to distinguish various degrees of (trans) portability, it is good to know the official terms as used within the international standards for medical devices, see Figure 2.

Miniaturized HD machines, designed for home use are brought on the market by several manufacturers: NxStage, Physidia, Quanta, and Tablo. All these are single-pass machines. It has been shown that reduction of dialysate flow to 300 ml/min can save water with a limited loss in efficacy and less risk for hypokalemia at the end of dialysis.<sup>52</sup>

Dialysate regeneration can enable further miniaturization. NextKidney has entered first-in-human trials of a portable hemodialysis machine designed for home use and traveling, that regenerates dialysate by sorbent cartridges so that it can be reused in a low-volume closed circuit. This allows miniaturization of the size of

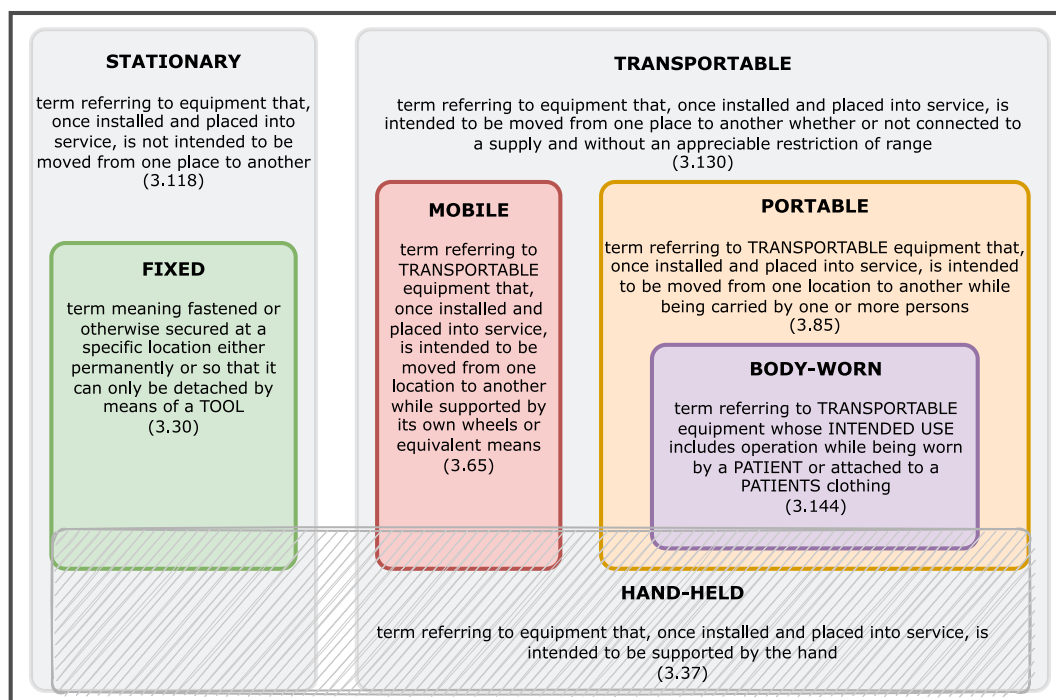

**FIGURE 2** Relationship of official terms used to describe various degrees of equipment portability within the worldwide applicable series of IEC standards on medical equipment. Reproduced with permission by NEN, Delft from IEC 60601-1 Amendment 1 of 2012, Figure A.20.

carry-on luggage for air travel.<sup>9</sup> Medtronic will soon be bringing a transportable machine for home hemodialysis to the market that also uses sorbent-based regeneration of dialysate.<sup>53,54</sup>

Such developments form the first steps on an innovation roadmap published by the Kidney Health Initiative (KHI) that, via portable, leads further toward wearable (body-worn) and even implantable KRT solutions.<sup>55</sup> The further sections of this paper will focus on developments toward wearable and implantable KRT that may provide significantly improved scenarios.

### 3 | ALTERNATIVE TECHNOLOGIES FOR DETOXIFICATION AND DEVELOPMENT OF WEARABLE AND IMPLANTABLE ARTIFICIAL KIDNEY DEVICES

#### 3.1 | Wearable systems for dialysis (WAK)

Miniaturization of artificial organs has already been achieved for the “artificial heart” and subsequently “ventricular assist devices” (VAD) that replace or support the pump function of the heart. The first total artificial heart was implanted in 1983<sup>56</sup> and required a large machine to transcutaneously power the heart, which could only be applied intramural. Today, however, miniaturized VADs can be implanted, using wearable external power and control units that permit patients to have an almost normal ambulatory life.<sup>57</sup> Development of wearable or implantable devices for KRT is desirable to allow continued treatment during normal daily activities. It will increase the

mobility of patients and possibly loosen dietary and fluid intake restrictions, all factors that improve QoL. Such devices are underway and will be discussed in subsequent sections of this survey.

As PD requires no blood access and the quantity of dialysis fluids required for removal of metabolites, uremic toxins and salts are lower than in HD, PD may permit a faster route toward wearable devices that may operate more safely than a wearable HD. A wearable HD still requires an external blood circuit with associated challenges.<sup>58</sup>

A truly wearable device must be lightweight and largely independent of electrical wall outlets (considerable runtime between battery charging sessions). The amount of dialysate should be minimized through continuous regeneration of the peritoneal dialysate by purification through sorbent columns, which traditionally contained activated carbon, zirconium, or polystyrene.<sup>59</sup>

Currently, several wearable PD designs have been proposed permitting continuous flow PD driven by pumps and a closed loop operation. In this section, we briefly discuss four wearable systems for PD and one for HD (see Table 2).

The Vicenza wearable artificial kidney (ViWAK), described by Ronco et al.,<sup>60</sup> is conceived to perform continuous flow PD, utilizing a double-lumen peritoneal catheter and a small battery-powered rotary pump. The ViWAK system uses activated carbon and polystyrene resins in a series of adsorption columns for continuous dialysate regeneration and contains a filter for deaeration and microbiological safety. For daytime dialysis, the peritoneal cavity is loaded with 2 L of standard glucose-based dialysate and after an initial 2 h dwell, dialysate is continuously recycled for 10 h. There is no specific ultrafiltration control, but glucose can

TABLE 2 Wearable devices for peritoneal and hemodialysis

Device	Features	Status of development	References
ViWAK	<ul style="list-style-type: none"> <li>double-lumen PD catheter</li> <li>polystyrenic resin and activated carbon</li> <li>standard glucose-based dialysate</li> </ul>	<ul style="list-style-type: none"> <li>In vitro studies</li> <li>No clinical trials</li> <li>no recent advances have been published</li> </ul>	[60,62]
AWAK	<ul style="list-style-type: none"> <li>single-lumen PD catheter</li> <li>modified REDY sorbent system</li> <li>standard glucose-based dialysate</li> </ul>	<ul style="list-style-type: none"> <li>clinical trials</li> </ul>	[63,67–69] <a href="http://www.awak.com">http://www.awak.com</a>
WEAKID <sup>a</sup>	<ul style="list-style-type: none"> <li>single-lumen PD catheter</li> <li>ion exchangers and activated carbon</li> </ul>	<ul style="list-style-type: none"> <li>in vivo studies (uremic pig model)</li> </ul>	[70,72]
CLS	<ul style="list-style-type: none"> <li>two single-lumen PD catheter</li> <li>ion exchangers and activated carbon</li> </ul>	<ul style="list-style-type: none"> <li>clinical trials</li> </ul>	[61,73] <a href="http://www.triomed.se">http://www.triomed.se</a>
Wearable HD device	<ul style="list-style-type: none"> <li>double-lumen catheter</li> <li>Gambro Polyflux 6H, Baxter dialyzer (0.6 m<sup>2</sup>)</li> <li>urease, ion exchangers, and activated charcoal</li> </ul>	<ul style="list-style-type: none"> <li>clinical trials</li> </ul>	[75,76]

Abbreviations: AWAK, automated wearable artificial kidney; HD, hemodialysis; CLS, carry life system; PD, peritoneal dialysis; REDY, REcirculating DialYsis; ViWAK, Vicenza wearable artificial kidney; WEAKID, wearable artificial kidney.

<sup>a</sup>WEAKID project has stopped, now Nanodialysis (<http://www.nanodialysis.nl>).



be optionally added to the regenerated dialysate to achieve ultrafiltration. After daytime therapy, dialysate has to drain out and a 2-L icodextrin exchange is performed overnight, maintaining electrolyte homeostasis. The ViWAK system is designed to enable continuous ambulatory peritoneal dialysis (CAPD) but would require the patient to perform two dialysate exchanges per day. Further potential limitations are given by the fact, that the ViWAK lacks a system for selective urea removal and a system to correct electrolyte changes.<sup>59,61</sup> Moreover, there is no filter to prevent cumulative protein buildup (e.g., fibrin) in the circulating dialysate, which may lead to protein coating of the sorbents, degrading their efficiency.<sup>62</sup> In vitro studies have shown an efficient removal of creatinine and middle molecules by sorbents.<sup>60</sup> However, because of the limitations, the ViWAK so far has not made it to animal or human clinical trials and no recent advances have been published.

The AWAK (automated wearable artificial kidney) presented by Lee and Roberts,<sup>63</sup> is another wearable peritoneal dialysis device, which is battery-operated and designed for continuous use. In contrast to the ViWAK, the AWAK has a single-lumen PD catheter. Standard glucose-based dialysate is initially infused into the patients' peritoneal cavity. Then dialysate recirculates in a tidal manner at 4 L/h, providing an equivalent dialysate flow of 96 L/day. As dialysate flow is intermittent, a storage compartment is required for dialysate. Dialysate regeneration is achieved through a sorbent cartridge based on modified REDY (REcirculating DialYsis) sorbent technology, which applies activated carbon, ion exchangers, and immobilized urease (mixed together) to enzymatically hydrolyze urea into ammonium and bicarbonate, and a fibrin/debris trap.<sup>64–66</sup> Furthermore, the AWAK has a degassing chamber to remove carbon dioxide and an ammonium sensor to detect sorbent saturation. The system is designed for continuous dialysate regeneration, with reuse of dialysate for up to one month. An additional chamber is integrated, containing electrolytes, lactate, and glucose, to compensate for changed amounts of these compounds in the regenerated dialysate. While dialysate needs replacement around once a month, the sorbent cartridges need to be exchanged every 4–8 h. To reduce the number of changes required, a sorbent cartridge with higher capacity can be used, which in turn is associated with a significant increase in weight. The AWAK has undergone animal and human clinical trials.<sup>67–69</sup> No serious adverse events were observed up to one month after treatment, but more than half of the patients complained of abdominal discomfort after dialysate was drained. Effective ultrafiltration and clearance of urea, creatinine, and phosphate were demonstrated. Clearance of the spent dialysate was found to be comparable to conventional PD. Commercial developments are still continuing.

The WEAKID project was funded by the EU and carried out by the University Medical Centre Utrecht (UMCU, The Netherlands) in close collaboration with Nanodialysis (The Netherlands).<sup>70</sup> Two types of WEAKID systems are designed: (1) a portable device for an overnight treatment, which has a larger capacity and (2) a smaller and wearable device for ambulant continuous treatment during the day. The dialysate is recirculated by a tidal mode using a single-lumen peritoneal catheter. Continuous regeneration of the dialysate is achieved by sorbent cartridges, which must be changed twice a day, containing activated carbon and ion exchangers. The device for overnight treatment contains a dialysate reservoir for the additional removal of urea. Moreover, the device has different sensors monitoring pressure, temperature, and air bubbles, and offers remote monitoring capability. Despite a lower supplement of glucose to the dialysate compared to conventional PD, WEAKID enables efficient ultrafiltration, because there is no static dwell, thereby maintaining a high osmotic gradient. Chronic exposure to high glucose concentration is toxic for tissue. Therefore, reducing the amount of glucose would be expected to prevent deterioration of the peritoneal membrane. In vitro studies confirmed the removal of potassium, phosphate, urea, and creatinine from the peritoneal dialysate. Moreover, phosphate, urea, and creatinine clearance from plasma (based on modeling) suggest superior efficiency compared to conventional PD.<sup>71</sup> A small study with uremic pigs showed promising results.<sup>72</sup> Clearances of creatinine and phosphate were enhanced 2-fold and 1.6-fold, respectively. The system is still in development.

The CLS was designed by the Swedish company Triomed AB (Lund, Sweden).<sup>61,73</sup> The CLS uses two single-lumen catheters providing continuous flow PD with continuous dialysate recirculation. However, a sorbent cartridge exchange is required every 4 h. Activated carbon and ion-exchangers ensure dialysate regeneration and concentrated glucose is continuously added to the regenerated dialysate before being returned to the patient. Before the CLS is connected to the patient and started, 2 L of dialysate are infused into the peritoneal cavity. In the first clinical trials, urea, creatinine, and phosphate clearance were achieved, comparable with that of automated PD.<sup>72</sup> Intraperitoneal glucose concentration was maintained during dialysis, enabling efficient ultrafiltration, and no adverse events or patients' discomfort were observed.<sup>73</sup>

Wearable devices for continuous flow PD may be a serious alternative to conventional PD that could enhance blood purification efficiency and offer patients more freedom in everyday life. A reduction of connections and disconnections of the PD catheter could reduce the risk of intra-luminal contamination and subsequent peritonitis.





Moreover, the risk of functional deterioration of the peritoneal membrane will be decreased through continuous but lower concentration of glucose infusion compared to conventional PD, enabling a more efficient long-term application. For the application of tidal PD in ambulatory patients and certainly for continuous flow PD, one needs to know the total volume of PD solution in the peritoneum. Completely draining the peritoneum to know this volume takes time and detracts from overall efficiency. Continuous measurement of regional bioimpedance of the peritoneum can give a fairly accurate measure of intraperitoneal volume but the electrode placement is still complicated and inconvenient.<sup>74</sup>

Further research is necessary regarding the miniaturization and simplification of such wearable devices. To combine low weight with adequate regeneration of the dialysate, the sorbent cartridges still must be replaced once or more per day. Furthermore, the urea removal strategy and the relatively large protein leakage into the peritoneal fluid still need improvement.

One advanced example of a wearable HD device with dialysate regeneration is the device developed by the group of Gura.<sup>75</sup> The wearable HD device works with a battery-driven pump that pumps heparinized blood through a hemodialyzer which is rinsed with dialysate in counter-current flow driven by the same pump. The dialysate is regenerated by a series of sorbent-containing cartridges which have urease, zirconium phosphate, hydrous zirconium oxide, and activated carbon. Miniaturized pumps are used for the anticoagulation of blood with heparin and adding sodium bicarbonate to the regenerated dialysate. The wearable HD has been already successfully applied in an FDA-approved clinical trial with five patients showing sufficient clearance of urea, creatinine, phosphorus, and also  $\beta_2$  microglobulin which may be considered a proof-of-concept for wearable HD devices.<sup>76</sup>

### 3.2 | Extracorporeal bioartificial kidney systems (BAK)

Dialysis with a purely mechanical device does not deliver the selective secretion and reabsorption of the renal tubule. Ikizler pioneered the observation that dialytic removal of amino acids stimulated catabolism of striated muscle during the treatment that persisted after the dialysis treatment was complete.<sup>77,78</sup> In contrast, healthy kidneys reabsorb filtered amino acids to defend the circulating pool of substrates for protein synthesis. Conversely, the renal tubule cells actively pump a range of solutes from the basolateral interstitium to the urine around the clock. Extremely low solute concentrations in the interstitium surrounding the peritubular capillary cause

protein-bound solutes in the peritubular capillary to dissociate from their protein carrier and diffuse to the tubule cell, where they are excreted. In this way, the kidney removes protein-bound uremic solutes despite glomerular retention of plasma proteins. Dialysis, on the contrary, has no such mechanism for protein-bound uremic toxins such as kynurenic acid, p-cresyl sulfate, and indoxyl sulfate accumulation. Not only are they toxic, but they also displace other molecules and drugs from the three Sudlow binding sites on albumin.

There were several attempts to construct bioartificial kidney systems (BAK) as extracorporeal devices, particularly for the treatment of acute kidney failure.

First studies to develop a BAK were done by Aebischer and colleagues who cultured kidney epithelial cells (canine MDCK and porcine LLC-PK1 cell lines) on the outer surface of semipermeable hollow fiber membranes of either acrylic copolymers or polysulfone studying their transport functions through the cell layer and membrane.<sup>79</sup> They observed differences in the behavior and functionality of kidney epithelial cells depending on the type of membrane. Their findings have spurred further attempts in membrane development for the culture of kidney epithelial cells trying copolymers of acrylonitrile with N-vinylpyrrolidone as hydrophilic comonomer that improved cell-cell contacts and with that trans-epithelial resistance that was considered as evidence for improved barrier and transport function of the epithelium.<sup>80,81</sup>

Developments to establish a BAK that combines the excretory and filtration function of the kidney glomerulus using a conventional hemofiltration unit with the re-adsorptive functions of the tubules applying bioreactors with kidney epithelial cells were primarily done by the group of Humes in the US and the group of Saito in Japan. Humes designed a device architecture combining a hemofilter that generates an ultrafiltrate which is connected to a bioreactor comprising a conventional hollow fiber reactor based on polysulfone membranes with proximal kidney epithelial cells for the re-adsorptive function of the kidney (see Figure 3).<sup>82,83</sup> Because of the insufficient biocompatibility of polysulfone, he used a coating of membranes with Pronectin-L (a protein resembling extracellular matrix protein fibronectin) to improve the functionality of the cell layer. The BAK device developed by Humes was operating with porcine kidney epithelial cells in preclinical studies, which were later replaced by human kidney epithelial cells obtained from kidneys not suitable for transplantation. The BAK underwent phase I and II clinical trials for the treatment of patients with acute renal failure (ARF) due to ischemic or nephrotoxic insults that normally have mortality greater than 50%. Although the treatment led to a statistically significant improved survival in the group treated for 72 h with the BAK compared

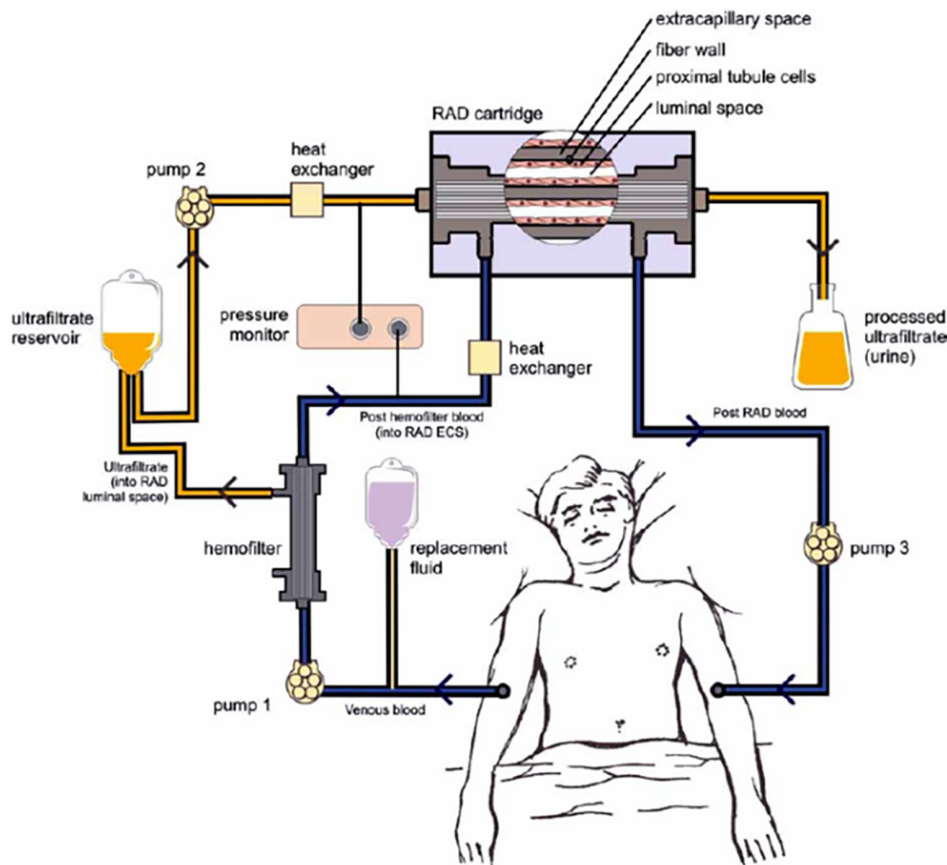

FIGURE 3 Scheme of the bioartificial kidney device developed by Humes et al. and used in preclinical and clinical studies. Reprinted with permission from Ref. [83] Copyright 2005, Elsevier.

to a non-treated control group, phase IIb trials were not completed due to difficulties with the manufacturing of the device and problems with the study design.<sup>84</sup>

The group of Saito et al. also used hollow fiber modules, but with ethylene vinyl alcohol copolymer (EVAL) membranes that were claimed to be superior to polysulfone, yet also required a coating with ECM molecules called “attachin” to improve the growth and functionality of kidney epithelial cells. This could demonstrate the functionality of the device in their studies.<sup>85</sup>

More recent successful attempts to improve the functionality of membranes to support colonization with functionally active kidney epithelial cells have been undertaken primarily by the group of Stamatialis. They used conventional membrane materials like polyethersulfone but modified them by binding extracellular matrix components like collagen IV.<sup>86</sup>

Other bioreactor designs like the fiber-in-fiber bioreactors for BAK could demonstrate the arrangement of kidney epithelial cells inside the inter-fiber space in a manner resembling that of kidney tubule. However, this device was not further tested due to difficulties with the manufacturing process and lacking interest of dialysis companies in further development.<sup>87</sup>

Further obstacles such as the lack of appropriate cells can be better addressed now by induced pluripotent stem cells. The remaining challenges of these devices are: (a) long-term blood and tissue compatibility of device components, (b) maintenance of transport properties of membranes despite the risk of fouling through adsorption of plasma proteins, and (c) the maintenance of the functionality of the epithelial cells for the duration of treatment. However, the BAK may serve as a functional template for wearable or implantable kidney replacements provided miniaturization of the device is possible that still has the potential to achieve the desired detoxification of and fluid removal from blood.

### 3.3 | Implantable artificial kidneys (IAK)

An IAK, (shown in Figure 4), must achieve two key goals: waste elimination and homeostasis of the extracellular fluid volume. IAK thus are organized around a thoughtful selection of functions, a balance of engineering and pharmacologic solutions to host tolerance, and life cycle management strategies that mitigate the burden on patients.

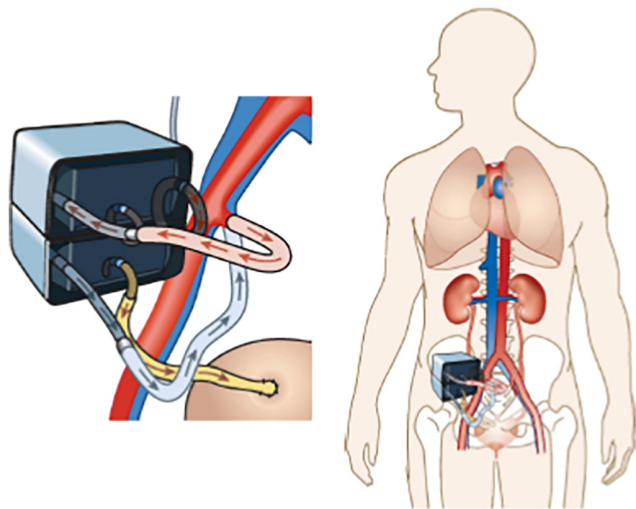

**FIGURE 4** Scheme of an implantable artificial kidney (IAK). The iliac vessels are used as intake of the arterial blood and outlet for the venous blood, while the removed waste is shunted to the bladder. Reprinted with permission from Ref. [59] Copyright 2013, Elsevier.

From their initial conception, designers of implantable bioartificial kidneys must select which of the dozen or more functions of the mammalian kidney they are to perform. Some functions of the kidney are completely dispensable as they are redundant (water balance can be and is regulated by thirst alone) or easily substituted by pharmacologic means (erythropoietin, vitamin D, hydroxylation). Other functions are essential (concentrating wastes from low concentration in the blood to high concentration in effluent) and still others may need to be consciously and continuously regulated by the patient or physician (potassium concentrations, extracellular fluid volume).

The construction and function of an IAK, which is being developed by the group of Roy and Fissell,<sup>59</sup> are inspired by earlier BAK systems, such as those developed by H. David Humes. Logically an implantable device will have much lower blood flow resistance than an extracorporeal device with needles, catheters, etc. This in turn enables using the natural blood pressure as a driving force, thereby avoiding the need for an artificial blood pump with its' associated energy supply. Implantation of the device would require a product safety level, mean time between failure (MTBF) and lifetime like that of VADs because complications like thrombosis may be life-threatening and would require elective or even emergency surgeries for replacement/repair. The implantable device might be connected to the iliac vessels with low resistance, but anastomosis to the IAK and blood compatibility of the device are major critical issues. Most blood-compatible coatings (e.g., heparin coating) do not have enough stability in the long-term run; others like coating with polyethylene glycol have limited effects. Recently developed coatings of silicon membranes with sulfobetaines

seem to be promising.<sup>88</sup> Disposing of the removed toxins and fluid load also forms a challenge. In optima forma, excretion via the bladder would be desired, see Figure 4.

Also, the IAK will represent a combination of a filtration device, small enough to be implantable, but with a surface area large enough to achieve the desired filtration function of kidney glomeruli, and a bioreactor filled with kidney epithelial cells that resemble the function of kidney tubules. Implantable filtration devices that address these requirements can be produced by photolithographically production of membranes made from silicon wafers, adjusting slit-shaped pores of 5–10 nm width with a precision and size distribution greatly exceeding that of conventional polymer membranes. Figure 5 shows a scanning electron micrograph of such a silicon membrane.<sup>59</sup>

Like the BAK also in IAK, the “glomerular” membrane must be connected to a tubule device to reabsorb ultrafiltrate, so that patients only produce 2L of urine daily with adequate excretion of waste products. First attempts to culture kidney epithelial cells on silicon membranes presented encouraging results, showing localization of zona occludens-1 to cell–cell junctions and acetylated tubulin in cilia suggesting a differentiated phenotype that formed epithelial monolayers with transepithelial resistance comparable to controls on conventional cell culture inserts, which can be considered as a sign of a functional epithelium. More recently, the team has published cell culture techniques in which primary renal tubule cells show diuretic-inhibitable sodium and water reabsorption, and expression of key transporters essential to their identity.<sup>89,90</sup> In this IAK, the immobilization of kidney epithelial cells on a nanoporous filter hinders the transport of molecules larger than 40kD, so that the allogeneic cells are grown in an immune sanctuary while maintaining the transport of electrolytes and small molecules. In 2021, they reported the first functional demonstration of an implanted, small-scale device combining a silicon filter with cell therapy in a healthy porcine model.<sup>91</sup> However, the great question remains what cell mass and surface area will be required to obtain a therapeutic-level device that may establish a sufficient excretory function over a clinically and economically viable period of time.

A huge additional value of the IAK compared to transplantation would be the elimination of immune suppression drugs. The present Covid-19 pandemic forms an extra highlight of the disadvantages accompanying immune suppression with present organ transplants!

### 3.4 | Brief survey on alternative approaches to solve the problem of CKD

Xenotransplantation with pigs as source of donor kidneys<sup>92–97</sup> is progressing from experimental studies from

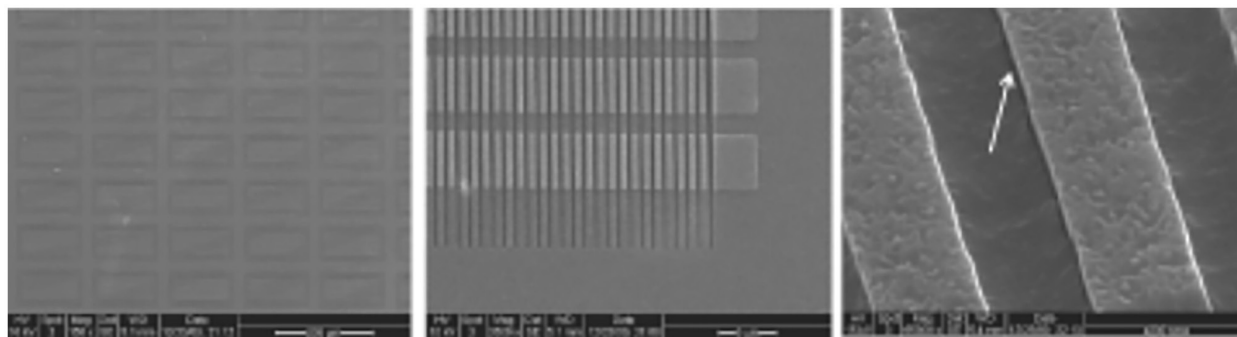

FIGURE 5 (A) Low magnification showing an array of rectangular membranes; (B) higher magnification showing the pores on a single membrane; (C) tilted, high magnification showing a close-up of the slit pore. Reprinted with permission from Ref. [59] Copyright 2013, Elsevier.

pig-to-non-human primates (NHP) to clinical trials with brain-dead patients. An excellent review on the state-of-the-art of porcine kidney xenotransplantation has been published recently by Cooper et al.<sup>93,98</sup> The most important prerequisite for xenotransplantation of porcine organs is the knockout of genes encoding for xenantigens particularly galactose- $\alpha$ 1, 3-galactose and other pig cell surface antigens eliciting a strong immune response in primates.<sup>98,99</sup> In addition, insertion of genes into the swine genome encoding for human complement regulatory and coagulation regulatory proteins has been performed to avoid activation of these pathways in recipients.<sup>100,101</sup> Despite these genetic modifications, it has been found necessary to have an initial anti-inflammatory therapy against TNF- $\alpha$  in NHP<sup>102</sup> and immune suppressive therapy against T-cell response addressing CD40:CD154 costimulatory pathway using monoclonal antibodies against one of these surface antigens.<sup>103,104</sup> It should be noted that conventional immune suppressive therapy is not successful.<sup>98</sup> Studies in NHP with transplantation of porcine kidneys show normal creatine levels over months with no signs of proteinuria, and a normal level of albumin but low phosphate concentration in plasma.<sup>102,105</sup> Several problems were observed during preclinical studies in baboons with porcine kidney transplantation such as hypovolemia and dehydration because the baboon kidney did not become aware of being volume-depleted indicating a malfunctioning of porcine renin/angiotensinogen system in NHP (i)<sup>106</sup>; doubts if the pig erythropoietin is functioning in NHP and humans<sup>105</sup> and rapid growth of transplanted kidneys in the recipient NHP.<sup>107</sup> Recently, the first clinical studies were done using genetically modified pigs with triple knockout genes to first temporally connect a xeno-kidney and implant a pair of xeno-kidneys into a brain-dead decedent.<sup>108</sup> These early clinical studies showed no adverse reactions vs. the grafted kidney and normal function for a period of up to 54 h with normal urine

production and no signs of hyperacute rejection.<sup>109</sup> On the other hand, the fatal outcome of first heart transplantation from a transgenic pig to a human due to an infection with porcine cytomegalovirus and subsequent responses of the recipient's immune system<sup>110</sup> sheds also a light on the potential risks of xenotransplantation due to zoonoses like those from PERVs or CMV.

Kidney engineering is another approach that is based on the use of human-sized native kidneys from pigs or discarded human organs in combination with primary kidney cells or induced pluripotent stem cells that can be differentiated into populations of renal cells. This includes whole organ decellularization using different types of protocols.<sup>111</sup> Critical issues during the process of decellularizing human-sized kidneys from pigs but also human kidneys are to effectively remove all cellular components including cell surface receptors and DNA to avoid immunological rejection, and to maintain the architecture of extracellular matrix components and vasculature after this treatment to permit effective recellularization.<sup>112,113</sup> It should be mentioned that the abundance of discarded human kidneys not useful for transplantation has also spurred attempts to use them as scaffolds for recellularization. Recent work from Orlando et al.<sup>114</sup> decellularizing human kidneys could also show effective removal of cellular components with the maintenance of the ECM components providing still spatial and biochemical cues.<sup>114</sup> However, a challenge of whole kidney engineering is the repopulation of cells in a spatial and functional appropriate manner. For the repopulation of human-sized kidneys 150 million endothelial cells (EC)<sup>115</sup> and hundreds of billion kidney epithelial cells (KEC) are needed.<sup>115,116</sup> Cells for repopulation can be obtained from different sources (e.g., kidney epithelial, endothelial, autologous somatic cells, induced pluripotent stem cells, or adult stem cells).<sup>94,117,118</sup> However, the use of cell populations derived from induced pluripotent stem cells seems to be advantageous compared to adult cells obtained from biopsies due to their potentially unlimited ability to proliferate





which may satisfy the needs of cells for repopulation of the kidney scaffold. Particularly induced pluripotent cells can be differentiated into the desired cell type (e.g., EC and different types of KEC)<sup>119</sup> which may also be obtained from the patient avoiding immunological problems, because current studies can demonstrate repopulation of human-sized renal scaffolds with cells showing some functional activity. However, repopulation with KEC was found predominantly in the medulla but lesser in the cortex of kidney scaffolds with incomplete colonization of the Bowman's capsule.<sup>111</sup> Experiments with EC repopulated human kidneys showed massive clotting within 5 min when they were perfused with human recalcified blood.<sup>115</sup> In summary, there is still a need for research until fully functional kidneys can be obtained by decellularization of pig and human donor kidneys and their repopulation with cells.

3D bioprinting is an emerging technique that allows the combination of bioinks that can represent components of the extracellular matrix with cells from different tissues and potentially organs in a structured manner. The printing process is in general a layer-by-layer approach when 2D objects are fused to obtain the desired 3D structure. Different types of bioprinting techniques such as inkjet-, extrusion-, laser(polymerization)-based, and other are available that permit a resolution of structures on the scale of the tenth to hundreds of micrometers.<sup>120,121</sup> While a major focus of bioprinting is currently on printing of relatively "simple" organized tissues like bone, cartilage, and skin for therapeutic interventions,<sup>122</sup> a major focus is currently also bioprinting different types of tumor and healthy tissue models that can be used in fundamental research and testing the effect of pharmaceuticals in more physiologically relevant 3D models to have more relevant *in vitro* models than conventional 2D cultures and pre-clinical rodent models.<sup>123,124</sup> Most challenging, however, remains the printing of solid organs due to their complexity regarding internal structures, intricate arrangement of ECM components and cells as well as vascularization and innervation required immediately after implantation to avoid hypoxia and necrosis of bioprinted tissues and organs.<sup>121</sup> Despite the recent advances in bioprinting also of kidney organoids,<sup>125</sup> the fabrication of a whole functional kidney needs further development for a realizable approach,<sup>126</sup> due to the structural and physiological complexity of the organ architecture,<sup>94,127,128</sup> while it holds promises for the future.

## 4 | CONCLUSIONS

The increasing number of people that suffer from CKD urges the development of safe, effective, and affordable methods of kidney replacement therapy that combine

sparse water consumption with long-term usability. Current mainstay techniques for patients with CKD, to prolong life, are at present HD and PD. These are based on intermittent treatment holding significant complications, limited QoL, and high costs. A preferable option for most patients is to receive a transplant kidney from a living or deceased donor which is also at risk for complications, limited organ survival, and at a high cost (albeit lower than dialysis). Intermittently a request for replacement therapy may be necessary.

Although xenotransplantation has been demonstrated with some success, safety concerns, immunosuppressive regimens, and accessibility of these modified organs represent limitations that will require further years of research. A substitute or bridge to transplantation in the future may be the results of artificial organ technologies that develop functioning kidneys by using decellularized human-sized kidneys and bioprinting. However, a truly comprehensive kidney with living cells based on these concepts must incorporate strategies for tolerance and reproducing the structure–function relationships of the nephron. These appear especially challenging for strategies organized around xenogenically sourced matrix scaffolds as the matrix obtained by decellularization or used as bioinks does not seem to encode an addressing scheme to locate infused cells to appropriate nephron segments, and the host's innate and acquired immune systems have free access to donor cells. Therefore, any cells of allogenic or xenogenic origin must be genomically engineered to eradicate troublesome antigens and some degree of pharmacologic immune suppression will likely be necessary.

Another option, that seems closer in time, is the wearable artificial kidney based on the HD or PD concept with improved sorbent materials. These techniques may improve the health state of patients by continuous removal of uremic toxins, increased mobility, and hence improved QoL besides low-cost options. In this regard, an extensive global expert survey revealed that major breakthroughs are expected to be most likely by wearable artificial kidneys and implantable artificial kidneys.<sup>129</sup> However, also the wearable PD concept needs to be further miniaturized. A problem of PD is the potential microbiological contamination of the intestine and the subcutaneous access channel of the catheters. Also, the composition of sorbent cartridges needs optimizing and the system developed for easy and sterile change. The wearable HD concept—in general—needs an optimized vascular access and preventive anticoagulation for long-term patency of access and prevention of clotting of dialyzers and absorbers. Closed systems will limit microbiological contamination within the dialysis device and reduce the risk for subsequent sepsis. More biocompatible membrane materials and sorbers,



which are under development,<sup>130</sup> will reduce the risk of clotting and infection.

On the other hand, the limits of implantable artificial kidneys thus are organized around a thoughtful selection of functions, balance of engineering and pharmacologic solutions to host tolerance, and life cycle management strategies that mitigate the burden on patients. Moreover, any implantable device draws intense scrutiny regarding lifecycle management as repair, replace, and renew cycles subject the patient to invasive procedures.

Overall, the concept of wearable and implantable artificial kidney is developed based on various technical principles. There still are technical and safety issues to improve before a widespread clinical use is implemented. However, smart solutions and concepts from various disciplines will help to speed up artificial organ technology in this field.

### AUTHOR CONTRIBUTIONS

All authors contributed equally to the design and drafting of the manuscript and were involved in the critical revision and approval of the article.

### ACKNOWLEDGMENTS

This work was partly supported by a grant from Deutsche Forschungsgemeinschaft to T.G. (Gr1290/13-1), the Dutch Kidney Foundation, and Njurforeningen Vasterbotten in Sweden. The authors are very thankful to Murray Sheldon, M.D. for initiating and supporting the topic of developing dialysis concepts, to be extended for use on a general basis in global communities. We are also indebted to The Association for Advancement of Medical Instrumentation (AAMI) for the permission of reproducing [Figure 1](#) in this review article, which is derived from AAMI TIR77: 2018.

### CONFLICT OF INTEREST

W.H.F. and S.R. are founders of Silicon Kidney, a spin-off company with the mission to incubate silicon membrane technology for biomedical applications. [Corrections added on 27 September, 2022: Conflict of interest statement was added]

### ORCID

Thomas Groth  <https://orcid.org/0000-0001-6647-9657>  
Fokko P. Wieringa  <https://orcid.org/0000-0002-7759-7816>

### REFERENCES

- Webster AC, Nagler EV, Morton RL, Masson P. Chronic kidney disease. *The Lancet*. 2017;389(10075):1238–52.
- Battle D, Soler MJ, Sparks MA, Hiremath S, South AM, Welling PA, et al. Acute kidney injury in COVID-19: emerging evidence of a distinct pathophysiology. *J Am Soc Nephrol*. 2020;31(7):1380–3.
- The United States Renal Data System. 2021 USRDS Annual Data Report: Epidemiology of kidney disease in the United States. Bethesda, MD: National Institutes of Health, National Institute of Diabetes and Digestive and Kidney Diseases; 2021.
- Luyckx VA, Tonelli M, Stanifer JW. The global burden of kidney disease and the sustainable development goals. *Bull World Health Organ*. 2018;96(6):414–422D.
- Bikbov B, Purcell CA, Levey AS, Smith M, Abdoli A, Abebe M, et al. Global, regional, and national burden of chronic kidney disease, 1990–2017: a systematic analysis for the Global Burden of Disease Study 2017. *Lancet*. 2020;395(10225):709–33.
- International Society of Nephrology. [cited 2022 Sep 14]. Available from: <https://www.who.int/ncds/governance/appendix3-international-society-of-nephrology.pdf?ua=1>
- Burton BT. Overview of end stage renal disease. *J Dial*. 1976;1(1):1–23.
- Lameire N, Van Biesen W, Vanholder R. Did 20 years of technological innovations in hemodialysis contribute to better patient outcomes? *Clin J Am Soc Nephrol*. 2009;4(Supplement 1):S30–40.
- Wieringa FP, Sheldon M, Ash SR, Groth T, Boomker J, Oostrom T, et al. Moving ahead on the kidney health initiative innovation roadmap, a transatlantic progress update. *Artif Organs*. 2020;44(11):1125–34.
- Ash SR, Groth T, Wieringa FP. Summary of the 2020 IFAO-ASAIO session on implantable artificial kidney. *ASAIO J*. 2020;66(10):e126–e7.
- Henderson L, Colton C, Ford C, Bosch J. Kinetics of hemodiafiltration. II. Clinical characterization of a new blood cleansing modality. 1975. *J Am Soc Nephrol*. 1997;8(3):494–508.
- Locatelli F, Karaboyas A, Pisoni RL, Robinson BM, Fort J, Vanholder R, et al. Mortality risk in patients on hemodiafiltration versus hemodialysis: a ‘real-world’ comparison from the DOPPS. *Nephrol Dial Transplant*. 2018;33(4):683–9.
- Cheng W, Luo Y, Wang H, Qin X, Liu X, Fu Y, et al. Survival outcomes of hemoperfusion and hemodialysis versus hemodialysis in patients with end-stage renal disease: a systematic review and meta-analysis. *Blood Purif*. 2022;51(3):213–25.
- Clark WR, Turk JE Jr. Approaches to quotidian dialysis: the NxStage system one. *Semin Dial*. 2004;17(2):167–70.
- Brunati CCM, Gervasi F, Cabibbe M, Ravera F, Menegotto A, Querques M, et al. Single session and weekly beta 2-microglobulin removal with different dialytic procedures: comparison between high-flux standard bicarbonate hemodialysis, post-dilution hemodiafiltration, short frequent hemodialysis with NxStage technology and automated peritoneal dialysis. *Blood Purif*. 2019;48(1):86–96.
- Ing T, Ronco C, Blagg C. High-intensity hemodialysis: the wave of the future? *Int J Artif Organs*. 2008;31(3):201–12.
- La Manna G, Donati G. Coupled plasma filtration adsorption: a multipurpose extracorporeal detoxification therapy. *Blood Purif*. 2018;46:228–38.
- Rayner HC, Zepel L, Fuller DS, Morgenstern H, Karaboyas A, Culleton BF, et al. Recovery time, quality of life, and mortality in hemodialysis patients: the Dialysis Outcomes and Practice Patterns Study (DOPPS). *Am J Kidney Dis*. 2014;64(1):86–94.
- Matsuda K, Fissell R, Ash S, Stegmayr B. Long-term survival for hemodialysis patients differ in Japan versus Europe and the USA. What might the reasons be? *Artif Organs*. 2018;12(42):1112–8.
- Hecking M, Bieber BA, Ethier J, Kautzky-Willer A, Sunder-Plassmann G, Säemann MD, et al. Sex-specific differences in hemodialysis prevalence and practices and the male-to-female



- mortality rate: the Dialysis Outcomes and Practice Patterns Study (DOPPS). *PLoS Med.* 2014;11(10):e1001750.
21. Wårja M, Laveborn E, Ott M, Jonsson AP, Stegmayr B. NT-pro-BNP as marker for cardiac strain that may be caused by high-output arteriovenous shunting in a haemodialysis patient. A case report. *BMC Nephrol.* 2020;21(1):1–6.
  22. Stegmayr B, Willems C, Groth T, Martins A, Neves NM, Mottaghy K, et al. Arteriovenous access in hemodialysis: a multidisciplinary perspective for future solutions. *Int J Artif Organs.* 2021;44(1):3–16.
  23. Stegmayr B. Air contamination during hemodialysis should be minimized. *Hemodial Int.* 2017;21(2):168–72.
  24. Forsberg U, Jonsson P, Stegmayr B. Air contamination during medical treatment results in deposits of microemboli in the lungs: an autopsy study. *Int J Artif Organs.* 2019;42(9):477–81.
  25. Chan CT, Blankestijn PJ, Dember LM, Gallieni M, Harris DCH, Lok CE, et al. Dialysis initiation, modality choice, access, and prescription: conclusions from a Kidney Disease: Improving Global Outcomes (KDIGO) Controversies Conference. *Kidney Int.* 2019;96(1):37–47.
  26. Crabtree JH, Shrestha BM, Chow KM, Figueiredo AE, Povlsen JV, Wilkie M, et al. Creating and maintaining optimal peritoneal dialysis access in the adult patient: 2019 update. *Perit Dial Int.* 2019;39(5):414–36.
  27. Stegmayr BG, Sperker W, Nilsson CH, Degerman C, Persson S-E, Stenbaek J, et al. Few outflow problems with a self-locating catheter for peritoneal dialysis: a randomized trial. *Medicine.* 2015;94(48):e2083.
  28. Nilsson C, Sperker W, Schien C, Isaksson M, Stegmayr BG. A surgical girdle postoperatively may prevent pain and tunnel infections of peritoneal dialysis patients. *Int J Artif Organs.* 2020;43(4):225–8.
  29. Vychtyl A, Hörl W. The role of tidal peritoneal dialysis in modern practice: a European perspective. *Kidney Int.* 2006;70:S96–S103.
  30. Ljungman S, Jensen JE, Paulsen D, Petersons A, Ots-Rosenberg M, Saha H, et al. Retraining for prevention of peritonitis in peritoneal dialysis patients: a randomized controlled trial. *Perit Dial Int.* 2020;40(2):141–52.
  31. Htay H, Johnson DW, Craig JC, Schena FP, Strippoli GF, Tong A, et al. Catheter type, placement and insertion techniques for preventing catheter-related infections in chronic peritoneal dialysis patients. *Cochrane Database Syst Rev.* 2019;5(5):1–120.
  32. Mehrotra R, Devuyst O, Davies SJ, Johnson DW. The current state of peritoneal dialysis. *J Am Soc Nephrol.* 2016;27(11):3238–52.
  33. Bonomini M, Zammit V, Divino-Filho JC, Davies SJ, Di Liberato L, Arduini A, et al. The osmo-metabolic approach: a novel and tantalizing glucose-sparing strategy in peritoneal dialysis. *J Nephrol.* 2020;1-17:503–19.
  34. Szeto CC, Johnson DW, editors. Low GDP solution and glucose-sparing strategies for peritoneal dialysis. *Semin Nephrol.* 2017;37(1):30–42.
  35. Association for the Advancement of Medical Instrumentation (AAMI). Sorbent-based regenerative hemodialysis systems. AAMI TIR77. 2018;1–31.
  36. Cornelis T, Eloot S, Vanholder R, Glorieux G, van der Sande FM, Scheijen JL, et al. Protein-bound uraemic toxins, dicarbonyl stress and advanced glycation end products in conventional and extended haemodialysis and haemodiafiltration. *Nephrol Dial Transplant.* 2015;30(8):1395–402.
  37. Chinnappa S, Tu Y-K, Yeh YC, Glorieux G, Vanholder R, Mooney A. Association between protein-bound uremic toxins and asymptomatic cardiac dysfunction in patients with chronic kidney disease. *Toxins.* 2018;10(12):520.
  38. Chao C-T, Lin S-H. Uremic vascular calcification: the pathogenic roles and gastrointestinal decontamination of uremic toxins. *Toxins.* 2020;12(12):812.
  39. Ahmed AR, Lappin D. Oral alkali therapy and the management of metabolic acidosis of chronic kidney disease: a narrative literature review. *World J Nephrol.* 2018;7(6):117–22.
  40. Kim HJ. Metabolic acidosis in chronic kidney disease: pathogenesis, clinical consequences, and treatment. *Electrolyte Blood Press.* 2021;19(2):29–37.
  41. Mathur V, Li E, Bushinsky DA. Safety and efficacy of everimer in acidotic patients with CKD and heart failure. *Kidney Int Rep.* 2021;6(11):2908–11.
  42. Ash SR, Singh B, Lavin PT, Stavros F, Rasmussen HS. A phase 2 study on the treatment of hyperkalemia in patients with chronic kidney disease suggests that the selective potassium trap, ZS-9, is safe and efficient. *Kidney Int.* 2015;88(2):404–11.
  43. Roger SD, Lavin PT, Lerma EV, McCullough PA, Butler J, Spinowitz BS, et al. Long-term safety and efficacy of sodium zirconium cyclosilicate for hyperkalaemia in patients with mild/moderate versus severe/end-stage chronic kidney disease: comparative results from an open-label, Phase 3 study. *Nephrol Dial Transplant.* 2021;36(1):137–50.
  44. Wadhwa NK, Kline JA, Adapa SR. The role of patiomer in delaying the onset of renal replacement therapy in patients with advanced renal failure. *Case Rep Nephrol.* 2021:6987456. <https://doi.org/10.1155/2021/6987456>
  45. Holleck JL, Roberts AE, Marhoffer EA, Grimshaw AA, Gunderson CG. Risk of intestinal necrosis with sodium polystyrene sulfonate: a systematic review and meta-analysis. *J Hosp Med.* 2021;16(8):489–94.
  46. Murea M, Patel A, Highland BR, Yang W, Fletcher AJ, Kalantar-Zadeh K, et al. Twice-weekly hemodialysis with adjuvant pharmacotherapy and transition to thrice-weekly hemodialysis: a pilot study. *Am J Kidney Dis.* 2021;80:227–240.e1.
  47. Fishbane S, Ford M, Fukagawa M, McCafferty K, Rastogi A, Spinowitz B, et al. A phase 3b, randomized, double-blind, placebo-controlled study of sodium zirconium cyclosilicate for reducing the incidence of predialysis hyperkalemia. *J Am Soc Nephrol.* 2019;30(9):1723–33.
  48. Ash SR, Carr DJ, inventors. US10668098B2, Oral sorbent for removing toxins of kidney failure combining anion and cation exchangers. 2020.
  49. Kitsche B, Bach D. Heimhämodialyse: Aktuelle Aspekte und Wandel in der Nierenersatztherapie Home hemodialysis Current aspects and transition in renal replacement therapy. *Der Nephrologe.* 2021; 16(5):292–298.
  50. Schreiber MJ, Chatoth DK, Salenger P. Challenges and opportunities in expanding home hemodialysis for 2025. *Adv Chronic Kidney Dis.* 2021;28(2):129–35.
  51. Saito A, Ohta Y, Sato K, Ichinose M, Arai T, Toyama K. Current international status of home hemodialysis. *Contrib Nephrol.* 2012;177:106–16.
  52. Wilcox SB, Carver M, Yau M, Sneeringer P, Prichard S, Alvarez L, et al. Results of human factors testing in a novel





- Hemodialysis system designed for ease of patient use. *Hemodial Int.* 2016;20(4):643–9.
53. Gerber MT, Hobot CM, inventors. WO2015199764A1, Replenishing urease in dialysis systems using urease pouches. 2015.
  54. Gerber MT, Hobot CM, inventors. WO2015199763A1, A urease introduction system for replenishing urease in a sorbent cartridge. 2015.
  55. Kidney Health Initiative. Technology roadmap for innovative approaches to renal replacement therapy. Washington, DC: The American Society for Nephrology and Kidney Health Initiative. 2018 [cited 2022 Sep 14]. Available from: <https://khi.asnonline.org/roadmap/>
  56. Cohn WE, Timms DL, Frazier O. Total artificial hearts: past, present, and future. *Nat Rev Cardiol.* 2015;12(10):609–17.
  57. Leff JD, Shore-Lesserson L, editors. Left ventricular assist devices: an evolving state of the art. In: Seminars in cardiothoracic and vascular anesthesia. Los Angeles, CA: SAGE Publications; 2010. Vol. 14, p. 21–23.
  58. Armignacco P, Lorenzin A, Neri M, Nalesso F, Garzotto F, Ronco C. Wearable devices for blood purification: principles, miniaturization, and technical challenges. *Semin Dial.* 2015;28(2):125–30.
  59. Fissell WH, Roy S, Davenport A. Achieving more frequent and longer dialysis for the majority: wearable dialysis and implantable artificial kidney devices. *Kidney Int.* 2013;84(2):256–64.
  60. Ronco C, Fecondini L. The Vicenza wearable artificial kidney for peritoneal dialysis (ViWAK PD). *Blood Purif.* 2007;25(4):383–8.
  61. van Gelder MK, Mihaila SM, Jansen J, Wester M, Verhaar MC, Joles JA, et al. From portable dialysis to a bioengineered kidney. *Expert Rev Med Devices.* 2018;15(5):323–36.
  62. Lee CJ, Rossi PJ. Portable and wearable dialysis devices for the treatment of patients with end-stage renal disease. *Hemodialysis access.* Springer, Cham; 2017. p. 349–53.
  63. Lee DB, Roberts M. A peritoneal-based automated wearable artificial kidney. *Clin Exp Nephrol.* 2008;12(3):171–80.
  64. Roberts M. The regenerative dialysis (REDY) sorbent system. *Nephrol Ther.* 1998;4(4):275–8.
  65. Blumenkrantz MJ, Gordon A, Roberts M, Lewin AJ, Pecker EA, Moran JK, et al. Applications of the Redy® sorbent system to hemodialysis and peritoneal dialysis. *Artif Organs.* 1979;3(3):230–6.
  66. van Gelder MK, Jong JA, Folkertsma L, Guo Y, Blüchel C, Verhaar MC, et al. Urea removal strategies for dialysate regeneration in a wearable artificial kidney. *Biomaterials.* 2020;234:119735.
  67. Basile C, Davenport A, Mitra S, Pal A, Stamatialis D, Chrysochou C, et al. Frontiers in hemodialysis: innovations and technological advances. *Artif Organs.* 2020;45:175–82.
  68. Htay H, Gow S, Jayaballa M, Oei E, Jamaluddin S, Lim J, et al. SUN-069 Evaluation of safety of automated wearable artificial kidney (AWAK) device in peritoneal dialysis patients. *Kidney Int Rep.* 2019;4(7):S183.
  69. American Society of Nephrology. Automated wearable artificial kidney may improve peritoneal dialysis. *ScienceDaily*; 2019. [cited 2021 Feb 18]. Available from: [www.sciencedaily.com/releases/2019/11/191108171643.htm](http://www.sciencedaily.com/releases/2019/11/191108171643.htm)
  70. Gerritsen K. WEAKID-Clinical validation of miniature wearable dialysis machine-H2020. *Impact.* 2018;2018(3):55–7.
  71. Gelder M, Simonis F, Hazenbrink D, Ligabue G, Cappelli G, Bajo Rubio M, et al. FP448A miniature artificial kidney for peritoneal dialysis—WEAKID. *Nephrol Dial Transplant.* 2018;33(suppl\_1):i186-i.
  72. van Gelder MK, de Vries JC, Simonis F, Monnikhof AS, Hazenbrink DH, Ligabue G, et al. Evaluation of a system for sorbent-assisted peritoneal dialysis in a uremic pig model. *Physiol Rep.* 2020;8(23):e14593.
  73. Samuelsson O, Heijdenberg L, de Leon C, Meinander NM, Persson E, Wramner L. Peritoneal dialysis with the new portable carry lifevr system. *Nephrol Dial Transplant.* 2018;33.
  74. Zhu F, Hoenich NA, Kaysen G, Ronco C, Schneditz D, Murphy L, et al. Measurement of intraperitoneal volume by segmental bioimpedance analysis during peritoneal dialysis. *Am J Kidney Dis.* 2003;42(1):167–72.
  75. Gura V, Macy AS, Beizai M, Ezon C, Golper TA. Technical breakthroughs in the wearable artificial kidney (WAK). *Clin J Am Soc Nephrol.* 2009;4(9):1441–8.
  76. Gura V, Rivara MB, Bieber S, Munshi R, Smith NC, Linke L, et al. A wearable artificial kidney for patients with end-stage renal disease. *JCI Insight.* 2016;1(8):e86397.
  77. Deger SM, Hung AM, Gamboa JL, Siew ED, Ellis CD, Booker C, et al. Systemic inflammation is associated with exaggerated skeletal muscle protein catabolism in maintenance hemodialysis patients. *JCI Insight.* 2017;2(22):e95185.
  78. Gamboa JL, Roshanravan B, Towse T, Keller CA, Falck AM, Yu C, et al. Skeletal muscle mitochondrial dysfunction is present in patients with CKD before initiation of maintenance hemodialysis. *Clin J Am Soc Nephrol.* 2020;15(7):926–36.
  79. Aebischer P, Ip T, Panol G, Galletti P. The bioartificial kidney: progress towards an ultrafiltration device with renal epithelial cells processing. *Life Supp Syst.* 1987;5(2):159–68.
  80. Fey-Lamprecht F, Gross U, Groth T, Albrecht W, Paul D, Fromm M, et al. Functionality of MDCK kidney tubular cells on flat polymer membranes for biohybrid kidney. *J Mater Sci Mater Med.* 1998;9(12):711–5.
  81. Groth T, Liu Z. Application of membranes in tissue engineering and biohybrid organ technology. In "Membranes for the Life Sciences". K-V Peinemann, S Pereira, editors. 2008;227–254. Weinheim, Germany: WILEY-VCH Verlag GmbH & Co. KGaA.
  82. Humes HD, Buffington DA, MacKay SM, Funke AJ, Weitzel WF. Replacement of renal function in uremic animals with a tissue-engineered kidney. *Nat Biotechnol.* 1999;17(5):451–5.
  83. Tiranathanagul K, Eiam-Ong S, Humes HD. The future of renal support: high-flux dialysis to bioartificial kidneys. *Crit Care Clin.* 2005;21(2):379–94.
  84. Humes HD, Buffington D, Westover AJ, Roy S, Fissell WH. The bioartificial kidney: current status and future promise. *Pediatr Nephrol.* 2014;29(3):343–51.
  85. Saito A, Sawada K, Fujimura S. Present status and future perspectives on the development of bioartificial kidneys for the treatment of acute and chronic renal failure patients. *Hemodial Int.* 2011;15(2):183–92.
  86. Chevtchik NV, Fedecostante M, Jansen J, Mihajlovic M, Wilmer M, Rütth M, et al. Upscaling of a living membrane for bioartificial kidney device. *Eur J Pharmacol.* 2016;790:28–35.
  87. Fey-Lamprecht F, Albrecht W, Groth T, Weigel T, Gross U. Morphological studies on the culture of kidney epithelial cells





- in a fiber-in-fiber bioreactor design with hollow fiber membranes. *J Biomed Mater Res A*. 2003;65(2):144–57.
88. Li L, Marchant RE, Dubnisheva A, Roy S, Fissell WH. Antibiofouling sulfobetaine polymer thin films on silicon and silicon nanopore membranes. *J Biomater Sci Polym Ed*. 2011;22(1–3):91–106.
  89. Love H, Evans R, Humes HD, Roy S, Zent R, Harris R, et al. Metformin and inhibition of transforming growth factor-beta stimulate in vitro transport in primary renal tubule cells. *Tissue Eng Part A*. 2020;26(19–20):1091–8.
  90. Love HD, Ao M, Jorgensen S, Swearingen L, Ferrell N, Evans R, et al. Substrate elasticity governs differentiation of renal tubule cells in prolonged culture. *Tissue Eng Part A*. 2019;25(13–14):1013–22.
  91. Available from: <https://www.asn-online.org/education/kidneyweek/2021/program-abstract.aspx?controlId=3604321>
  92. Shaw BI, Kirk AD. Kidney xenotransplantation: steps toward clinical application. *Clin J Am Soc Nephrol*. 2019;14(4):620–2.
  93. Cooper DK, Hara H, Iwase H, Yamamoto T, Jagdale A, Kumar V, et al. Clinical pig kidney xenotransplantation: how close are we? *J Am Soc Nephrol*. 2020;31(1):12–21.
  94. Peired AJ, Mazzinghi B, De Chiara L, Guzzi F, Lasagni L, Romagnani P, et al. Bioengineering strategies for nephrologists: kidney was not built in a day. *Expert Opin Biol Ther*. 2020;20(5):467–80.
  95. Yokoo T, Yamanaka S, Kobayashi E. Xeno-regenerative medicine: A novel concept for donor kidney fabrication. *Xenotransplantation*. 2020;27(5):e12622.
  96. Meier RP, Longchamp A, Mohiuddin M, Manuel O, Vrakas G, Maluf DG, et al. Recent progress and remaining hurdles toward clinical xenotransplantation. *Xenotransplantation*. 2021;28:e12681.
  97. Buchwald JE, Martins PN. Designer organs: The future of personalized transplantation. *Artif Organs*. 2022;46(2):180–90.
  98. Cooper DKC, Hara H, Iwase H, Yamamoto T, Wang ZY, Jagdale A, et al. Pig kidney xenotransplantation: progress toward clinical trials. *Clin Transplant*. 2021;35(1):e14139.
  99. Galili U, Shohet SB, Kobrin E, Stults CL, Macher BA. Man, apes, and Old World monkeys differ from other mammals in the expression of alpha-galactosyl epitopes on nucleated cells. *J Biol Chem*. 1988;263(33):17755–62.
  100. Wang L, Cooper DK, Burdorf L, Wang Y, Iwase H. Overcoming coagulation dysregulation in pig solid organ transplantation in nonhuman primates: recent progress. *Transplantation*. 2018;102(7):1050–8.
  101. Miyagawa S, Yamamoto A, Matsunami K, Wang D, Takama Y, Ueno T, et al. Complement regulation in the GalT KO era. *Xenotransplantation*. 2010;17(1):11–25.
  102. Iwase H, Hara H, Ezzelarab M, Li T, Zhang Z, Gao B, et al. Immunological and physiological observations in baboons with life-supporting genetically engineered pig kidney grafts. *Xenotransplantation*. 2017;24(2):e12293.
  103. Bühler L, Awwad M, Basker M, Gojo S, Watts A, Treter S, et al. High-dose porcine hematopoietic cell transplantation combined with CD40 ligand blockade in baboons prevents an induced anti-pig humoral response. *Transplantation*. 2000;69(11):2296–304.
  104. Mohiuddin MM, Singh AK, Corcoran PC, Thomas ML III, Clark T, Lewis BG, et al. Chimeric 2C10R4 anti-CD40 antibody therapy is critical for long-term survival of GTKO. hCD46. hTBM pig-to-primate cardiac xenograft. *Nat Commun*. 2016;7(1):1–10.
  105. Iwase H, Klein EC, Cooper DK. Physiologic aspects of pig kidney transplantation in nonhuman primates. *Comp Med*. 2018;68(5):332–40.
  106. Iwase H, Yamamoto T, Cooper DK. Episodes of hypovolemia/dehydration in baboons with pig kidney transplants: a new syndrome of clinical importance? *Xenotransplantation*. 2019;26(2):e12472.
  107. Tanabe T, Watanabe H, Shah JA, Sahara H, Shimizu A, Nomura S, et al. Role of intrinsic (graft) versus extrinsic (host) factors in the growth of transplanted organs following allogeneic and xenogeneic transplantation. *Am J Transplant*. 2017;17(7):1778–90.
  108. Porrett PM, Orandi BJ, Kumar V, Houp J, Anderson D, Cozette Killian A, et al. First clinical-grade porcine kidney xenotransplant using a human decedent model. *Am J Transplant*. 2022;22:1037–53.
  109. Montgomery RA, Stern JM, Lonze BE, Tatapudi VS, Mangiola M, Wu M, et al. Results of two cases of pig-to-human kidney xenotransplantation. *New Engl J Med*. 2022;386(20):1889–98.
  110. Regalado A. The gene-edited pig heart given to a dying patient was infected with a pig virus. *MIT Technology Review*. 2022 [cited 2022 Sep 14]. Available from: <https://www.technologyreview.com/2022/05/04/1051725/xenotransplant-patient-died-received-heart-infected-with-pig-virus/>
  111. de Haan MJ, Witjas FM, Engelse MA, Rabelink TJ. Have we hit a wall with whole kidney decellularization and recellularization: a review. *Curr Opin Biomed Eng*. 2021;20:100335.
  112. Kim I-H, Ko IK, Atala A, Yoo JJ. Whole kidney engineering for clinical translation. *Curr Opin Organ Transplant*. 2015;20(2):165–70.
  113. Yang J, Dang H, Xu Y. Recent advancement of decellularization extracellular matrix for tissue engineering and biomedical application. *Artif Organs*. 2022;46(4):549–67.
  114. Orlando G, Booth C, Wang Z, Totonelli G, Ross CL, Moran E, et al. Discarded human kidneys as a source of ECM scaffold for kidney regeneration technologies. *Biomaterials*. 2013;34(24):5915–25.
  115. Leuning DG, Witjas FM, Maanaoui M, de Graaf AM, Lievers E, Geuens T, et al. Vascular bioengineering of scaffolds derived from human discarded transplant kidneys using human pluripotent stem cell-derived endothelium. *Am J Transplant*. 2019;19(5):1328–43.
  116. Remuzzi A, Figliuzzi M, Bonandrini B, Silvani S, Azzollini N, Nossa R, et al. Experimental evaluation of kidney regeneration by organ scaffold recellularization. *Sci Rep*. 2017;7(1):1–13.
  117. Destefani AC, Sirtoli GM, Nogueira BV. Advances in the knowledge about kidney decellularization and repopulation. *Front Bioeng Biotechnol*. 2017;5:34.
  118. Kim SC, Mathews DV, Breeden CP, Higginbotham LB, Ladowski J, Martens G, et al. Long-term survival of pig-to-rhesus macaque renal xenografts is dependent on CD4 T cell depletion. *Am J Transplant*. 2019;19(8):2174–85.
  119. de Carvalho RP, Oliveira LF, Filho MA, Caldas HC. Differentiating induced pluripotent stem cells into renal cells: a new approach to treat kidney diseases. *Stem Cells Int*. 2020;2020:8894590.
  120. Xiang Y, Miller K, Guan J, Kiratitanaporn W, Tang M, Chen S. 3D bioprinting of complex tissues in vitro: state-of-the-art and future perspectives. *Arch Toxicol*. 2022;96:691–710.



121. Murphy SV, Atala A. 3D bioprinting of tissues and organs. *Nat Biotechnol.* 2014;32(8):773–85.
122. Yang Z, Yi P, Liu Z, Zhang W, Mei L, Feng C, et al. Stem cell-laden hydrogel-based 3d bioprinting for bone and cartilage tissue engineering. *Front Bioeng Biotechnol.* 2022;10:865770.
123. Datta P, Dey M, Ataie Z, Unutmaz D, Ozbolat IT. 3D bioprinting for reconstituting the cancer microenvironment. *NPJ Precis Oncol.* 2020;4(1):1–13.
124. Peng W, Unutmaz D, Ozbolat IT. Bioprinting towards physiologically relevant tissue models for pharmaceuticals. *Trends Biotechnol.* 2016;34(9):722–32.
125. Humphreys BD. Bioprinting better kidney organoids. *Nat Mater.* 2021;20(2):128–30.
126. Turunen S, Kaisto S, Skovorodkin I, Mironov V, Kalpio T, Vainio S, et al. 3D bioprinting of the kidney—hype or hope? *AIMS Cell Tissue Eng.* 2018;2(3):119–62.
127. Vijayavenkataraman S, Yan W-C, Lu WF, Wang C-H, Fuh JYH. 3D bioprinting of tissues and organs for regenerative medicine. *Adv Drug Deliv Rev.* 2018;132:296–332.
128. Sohn S, Buskirk MV, Buckenmeyer MJ, Londono R, Faulk D. Whole organ engineering: approaches, challenges, and future directions. *Appl Sci.* 2020;10(12):4277.
129. Pereira Cabral B, Bonventre JV, Wieringa F, Mota FB. Probing expert opinions on the future of kidney replacement therapies. *Artif Organs.* 2021;45(1):79–87.
130. Basile C, Davenport A, Mitra S, Pal A, Stamatialis D, Chrysochou C, et al. Frontiers in hemodialysis: innovations and technological advances. *Artif Organs.* 2021;45:175–82.

**How to cite this article:** Groth T, Stegmayr BG, Ash SR, Kuchinka J, Wieringa FP, Fissell WH, et al. Wearable and implantable artificial kidney devices for end-stage kidney disease treatment: Current status and review. *Artif. Organs.* 2023;47:649–666. <https://doi.org/10.1111/aor.14396>